



OPERATION MANUAL

Steam humidifier
Condair EL

Thank you for choosing Condair

Installation date (MM/DD/YYYY):

Commissioning date (MM/DD/YYYY):

Site:

Model:

Serial number:

Proprietary Notice

This document and the information disclosed herein are proprietary data of Condair Group AG. Neither this document, nor the information contained herein shall be reproduced, used, or disclosed to others without the written authorisation of Condair Group AG, except to the extent required for installation or maintenance of recipient's equipment.

Liability Notice

Condair Group AG does not accept any liability due to incorrect installation or operation of the equipment or due to the use of parts/components/equipment that are not authorised by Condair Group AG.

Copyright Notice

© Condair Group AG, All rights reserved.

Technical modifications reserved

Contents

1	Introduction	5
1.1	To the very beginning	5
1.2	Notes on the operation manual	5
2	For your safety	7
3	Product Overview	9
3.1	Construction Condair EL steam humidifier	9
3.2	Functional description	10
3.3	System overview Condair EL for duct humidification	11
3.4	System overview Condair EL for direct room humidification	12
4	Operation	13
4.1	First-time commissioning	13
4.2	Display and operating elements	13
4.3	Commissioning after an interruption of operation	14
4.4	Notes on operation	15
4.4.1	Inspections during operation	15
4.4.2	Remote operating and fault indication	15
4.4.3	Draining of the steam cylinder(s)	16
4.5	Taking the unit out of operation	17
5	Operating the control software	18
5.1	Standard operating display	18
5.1.1	Operating status indication	19
5.1.2	Maintenance and malfunction indications	19
5.2	Navigating/Operating the control software	20
5.3	Information functions	21
5.3.1	Accessing support informations	21
5.3.2	Accessing system informations	21
5.4	Configuration	26
5.4.1	Accessing the "Configuration" submenu	26
5.4.2	Determining unit settings – "Features menu" submenu	26
5.4.3	Humidity control Settings – "Control Settings" submenu	32
5.4.4	Basic settings – "General" submenu	39
5.4.5	Communication settings – "Communication" submenu	40
5.5	Maintenance functions	44
5.5.1	Accessing the "Service" submenu	44
5.5.2	Performing maintenance functions – "Service" submenu	44
5.5.2.1	Input diagnostic functions – "Input Diagnostics" submenu	46
5.5.2.2	Relay diagnostic functions – "Relay Diagnostics" submenu	48
5.6	Administration settings	49
5.6.1	Accessing "Administrator" submenu	49
5.6.2	Switching on/off password protection and software updates function - submenu "Administrator"	49

6	Maintenance	51
6.1	Important notes on maintenance	51
6.2	Maintenance intervals	52
6.3	Removing and installing components for maintenance	53
6.3.1	Removal and installation of the steam cylinder	53
6.3.2	Disassembly and assembly of the cleanable steam cylinder type D...	55
6.3.3	Removal and installation of the fill cup and the water hoses	56
6.3.4	Removal and installation of the drain pump	57
6.3.5	Removal and installation of the inlet valve	58
6.3.6	Removal and installation of the steam cylinder receptacle	59
6.3.7	Removal and installation of the drain cup	60
6.4	Notes on cleaning the unit components	61
6.5	Notes on cleaning agents	63
6.6	Resetting the cylinder status	64
6.7	Performing software and firmware updates	65
7	Fault elimination	67
7.1	Fault indication	67
7.2	Malfunction list	68
7.3	Saving fault and service histories to a USB memory stick	72
7.4	Notes on fault elimination	73
7.5	Resetting the fault indication	73
7.6	Replacing the fuses and backup battery in the control compartment	74
8	Taking out of service/Disposal	75
8.1	Taking out of service	75
8.2	Disposal/Recycling	75
9	Product specification	76
9.1	Performance data	76
9.2	Operating data	78
9.3	Connections/Dimensions/Weights	78
9.4	Certificates	78

1 Introduction

1.1 To the very beginning

We thank you for having purchased the **Condair EL steam humidifier**.

The Condair EL steam humidifier incorporates the latest technical advances and meets all recognized safety standards. Nevertheless, improper use of the Condair EL steam humidifier may result in danger to the user or third parties and/or impairment of material assets.

To ensure a safe, proper, and economical operation of the Condair EL steam humidifier, please observe and comply with all information and safety instructions contained in the present documentation as well as in the separate documentations of the components installed in the humidification system.

If you have questions after reading this documentation, please contact your Condair representative. They will be glad to assist you.

1.2 Notes on the operation manual

Limitation

The subject of this operation manual is the Condair EL steam humidifier in its different versions. The various options and accessories are only described insofar as this is necessary for proper operation of the equipment. Further information on options and accessories can be obtained in the respective instructions.

This operation manual is restricted to the **commissioning, operation, maintenance and troubleshooting** of the Condair EL steam humidifier and is meant for **well trained personnel being sufficiently qualified for their respective work**.

This operation manual is supplemented by various separate items of documentation (installation manual, spare parts list, etc.), which are included in the delivery as well. Where necessary, appropriate cross-references are made to these publications in the operation manual.

Symbols used in this manual



The catchword "CAUTION" used in conjunction with the caution symbol in the circle designates notes in this operation manual that, if neglected, may cause **damage and/or malfunction of the unit or other material assets**.



The catchword "WARNING" used in conjunction with the general caution symbol designates safety and danger notes in this operation manual that, if neglected, may cause **injury to persons**.



The catchword "DANGER" used in conjunction with the general caution symbol designates safety and danger notes in this operation manual that, if neglected, may lead to **severe injury or even death of persons**.

Safekeeping

Please safeguard this operation manual in a safe place, where it can be immediately accessed. If the equipment changes hands, the documentation must be passed on to the new operator.

If the documentation gets misplaced, please contact your Condair representative.

Language versions

This operation manual is available in various languages. Please contact your Condair representative for information.

2 For your safety

General

Every person working with the Condair EL must have read and understood the operation manual of the Condair EL before carrying out any work.

Knowing and understanding the contents of the operation manual is a basic requirement for protecting personnel against any kind of danger, to prevent faulty operation, and to operate the Condair EL safely and correctly.

All icons, signs and markings applied to the components of the Condair EL must be observed and kept in readable state.

Qualification of personnel

All work described in this operation manual **may only be carried out by specialists who are well trained and adequately qualified and are authorized by the customer.**

For safety and warranty reasons any action beyond the scope of this manual must be carried out only by qualified personnel authorised by the manufacturer.

It is assumed that all persons working with the Condair EL are familiar and comply with the appropriate regulations on work safety and the prevention of accidents.

The Condair EL steam humidifier may not be used by persons (including children) with reduced physical, sensory or mental abilities or persons with lacking experience and/or knowledge, unless they are supervised by a person responsible for their safety or they received instructions on how to operate the system. Children must be supervised to make sure that they do not play with the Condair EL steam humidifier.

Intended use

The Condair EL steam humidifier is intended exclusively for **air humidification via a steam distributor or blower pack approved by Condair within specified operating conditions.** Any other type of application, without the written consent of Condair, is considered as not conforming with the intended purpose and may lead to dangerous operation and will void any warranty.

Operation of the equipment in the intended manner requires **that all the information contained in this operation manual are observed (in particular the safety instructions).**

Danger that may arise from the Condair EL steam humidifier



DANGER!
Danger of electric hazard!

The Condair EL is mains powered. Live parts may be exposed when the door panels of the steam humidifier are removed. Touching live parts may cause severe injury or danger to life.

Prevention: Before carrying out any work set the Condair EL out of operation as described in [chapter 4.5](#) (switch off the unit, disconnect it from the mains and stop the water supply) and secure the unit against inadvertent power-up.



WARNING!
Hot water vapour - Danger of scalding!

The Condair EL produces hot water vapour. There is danger of scalding when coming in contact with hot water vapour.

Prevention: Do not carry out any work on the steam system during operation (steam lines, steam distributor, blower pack, etc.). If the steam system is leaky set the Condair EL immediately out of operation as described in [chapter 4.5](#). Correctly seal the steam system before putting the unit into operation again.



WARNING!
Danger of burning!

During operation the components of the steam system (steam cylinder, steam distributor, etc.) get very hot (up to 100 °C). There is danger of burning when touching the hot components.

Prevention: Before carrying out any work on the steam system set the Condair EL out of operation as described in [chapter 4.5](#), then wait until the components have cooled down sufficiently thus preventing danger of burning.

Preventing unsafe operation

If it is suspected that **safe operation is no longer possible**, the Condair EL should immediately **be shut down and secured against accidental power-up according to [chapter 4.5](#)**. This can be the case under the following circumstances:

- if the Condair EL is damaged
- if the electrical installations are damaged
- if the Condair EL is no longer operating correctly
- if connections and/or piping are not sealed

All persons working with the Condair EL must report any alterations to the unit that may affect safety to the owner without delay.

Prohibited modifications to the unit

No modifications must be undertaken on the Condair EL without the express written consent of Condair.

For the replacement of defective components use exclusively **original accessories and spare parts** available from your Condair representative.

3 Product Overview

3.1 Construction Condair EL steam humidifier

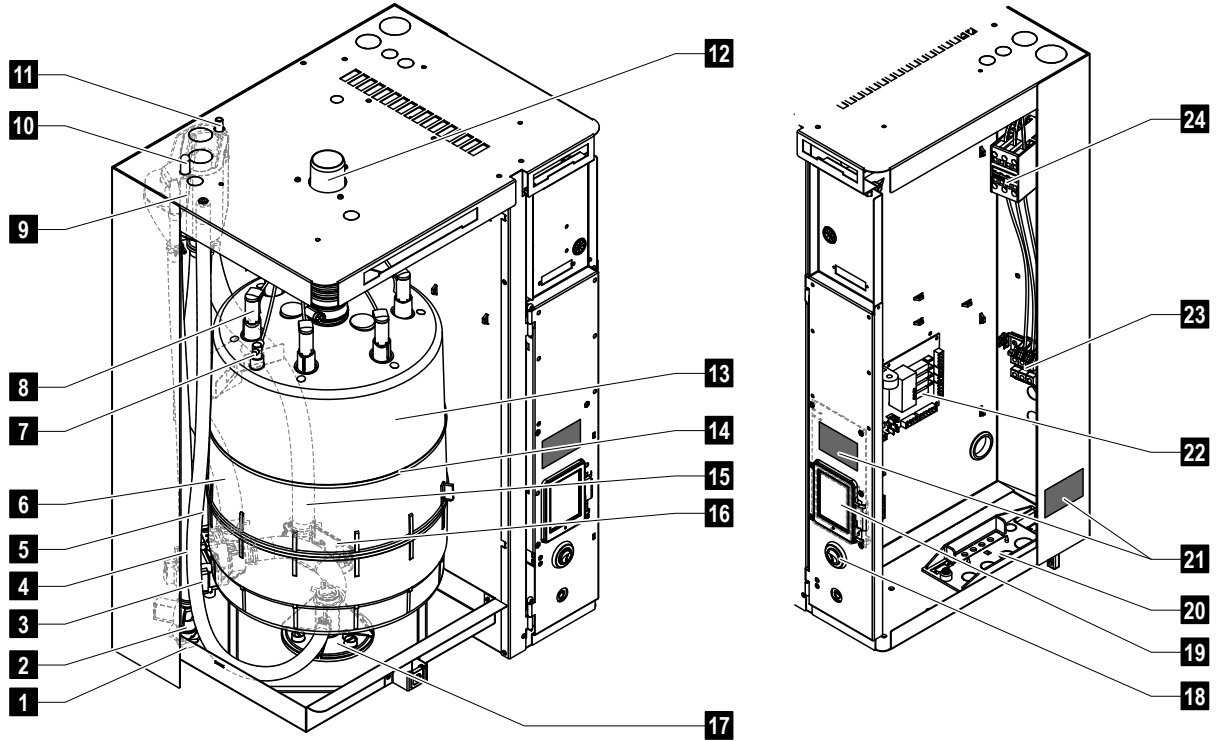

- | | |
|---------------------------------------|--|
| 1 Water supply connector (G 3/4") | 13 Steam cylinder |
| 2 Inlet valve | 14 Fastening strap steam cylinder |
| 3 Drain pump | 15 Drain hose |
| 4 Water supply hose | 16 Drain cup with drain connector (ø30 mm) |
| 5 Auxiliary drain hose | 17 Cylinder receptacle |
| 6 Water filling and drain hose | 18 Unit switch |
| 7 Level sensor | 19 Control board with display and control unit |
| 8 Electrode plug | 20 Cable feed through plate |
| 9 Fill cup | 21 Rating plate |
| 10 Condensate connector (to cylinder) | 22 Driver board |
| 11 Condensate connector (to drain) | 23 Terminal heating voltage supply (option) |
| 12 Steam outlet | 24 Main contactor |

Fig. 1: Construction Condair EL steam humidifier (figure shows medium sized unit)

3.2 Functional description

The Condair EL steam humidifier is an atmospheric steam generator. It operates on the electrode heating principle and is designed for direct room air humidification (with blower pack) and indirect humidification (with steam distributor) in ventilating and air-conditioning systems.

Water supply

The water is supplied via a filter valve (accessory "Z261") to the steam humidifier. It reaches the steam cylinder via the inlet valve and the open fill cup.

Steam generation

Any time steam is requested, the electrodes are supplied with voltage via the main contactor. Simultaneously, the inlet valve opens and the water enters the steam cylinder from the bottom via the open fill cup and filling hose. As soon as the electrodes come in contact with the water, current begins to flow between the electrodes, generating heat and increasing the water evaporation rate. The more of the electrode surface area that is exposed to conductive water, the higher the current consumption and thus steam production.

Upon reaching the requested steam capacity, the inlet valve closes. If the steam generation decreases below a certain percentage of the required capacity, due to lowering of the water level (e.g. because of the evaporation process or drainage), the inlet valve opens until the required capacity is available again. If the required steam capacity is lower than the actual output, the inlet valve is closed until the desired capacity is achieved by lowering of the water level (evaporation process).

Level monitoring

A sensor, provided in the steam cylinder, detects when the cylinder water level is at the maximum. When the sensor comes in contact with water, the inlet valve will close after a short delay.

Drainage

As a result of the evaporation and refill process, the conductivity of the water increases due to an escalating mineral concentration. Eventually, an inadmissibly high current consumption would take place if this concentration process were permitted to continue. To prevent this concentration from reaching a value, unsuitably high for the operation, a certain amount of water is periodically drained from the cylinder and replaced by fresh water.

Control

The steam production can be controlled via the internal or an external continuous Proportional (P)/Proportional-Integral (PI) controller or with an On/Off control via an external humidistat.

3.3 System overview Condair EL for duct humidification

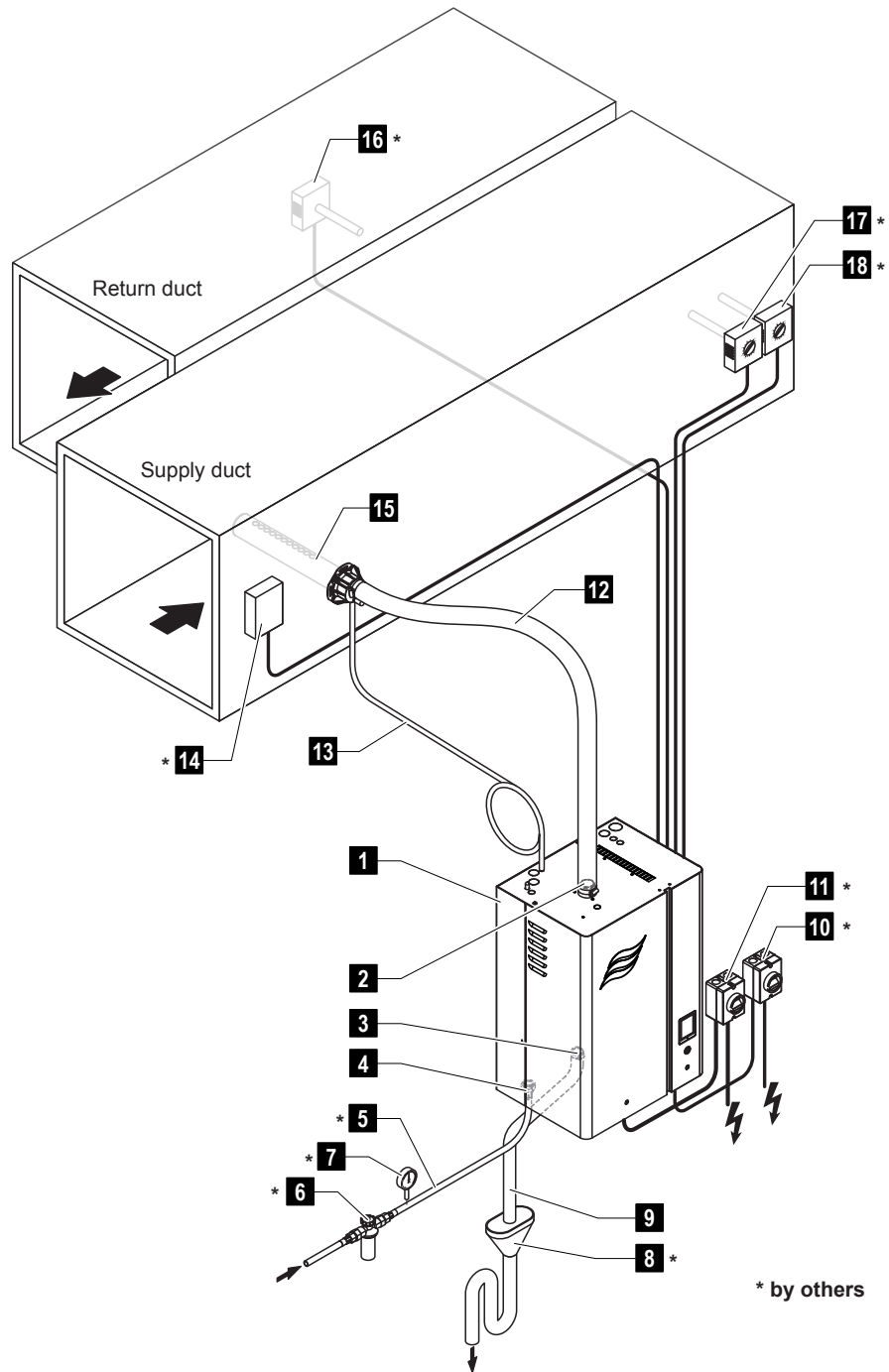

- | | |
|---------------------------------|---|
| 1 Steam humidifier | 10 Electrical isolator control voltage supply |
| 2 Steam outlet connector | 11 Electrical isolator heating voltage supply |
| 3 Water drain connector | 12 Steam line (accessory DS..) |
| 4 Water supply connector | 13 Condensate line (accessory KS10) |
| 5 Water supply line | 14 Air proving switch |
| 6 Filter valve (accessory Z261) | 15 Steam distributor (accessory DV..) |
| 7 Manometer (recommended) | 16 Humidity controller or humidity sensor |
| 8 Open funnel with water trap | 17 Humidity controller or humidity sensor |
| 9 Drain hose (supplied) | 18 High limit humidistat |

* by others

Fig. 2: System overview Condair EL for duct humidification

3.4 System overview Condair EL for direct room humidification

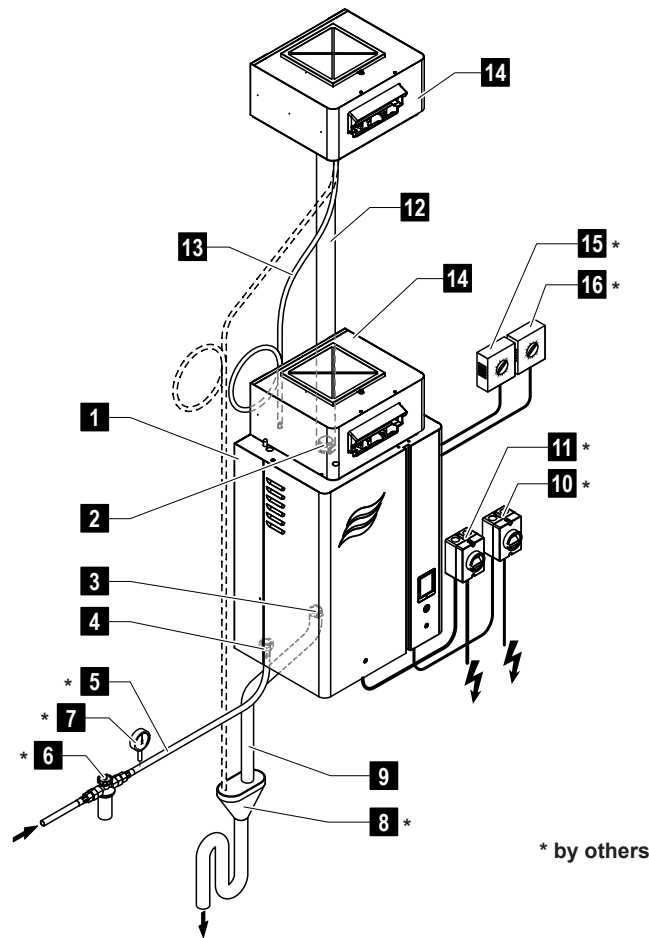

* by others

- | | |
|---|---|
| 1 Steam humidifier | 9 Drain hose (supplied) |
| 2 Steam outlet connector | 10 Electrical isolator control voltage supply |
| 3 Water drain connector | 11 Electrical isolator heating voltage supply |
| 4 Water supply connector | 12 Steam line (accessory DS80) |
| 5 Water supply line | 13 Condensate line (accessory KS10) |
| 6 Filter valve (accessory Z261) | 14 Blower Pack (accessory BP) |
| 7 Manometer (recommended) | 15 Humidity controller or humidity sensor |
| 8 Open funnel with water trap (building side) | 16 High limit humidistat |

Fig. 3: System overview Condair EL for direct room humidification

4 Operation

The Condair EL steam humidifier may be commissioned and operated only by persons familiar with the Condair EL steam humidifier and adequately qualified. It is the owner's responsibility to verify proper qualification of the personnel.

4.1 First-time commissioning

The first-time commissioning must always be done by a service technician of your Condair representative or a well trained and authorised person of the customer. Therefore the current manual does not provide detailed information on this procedure.

The following steps are carried out upon first-time commissioning in the specified order:

- Inspecting the steam humidifier for correct installation.
- Inspecting the electrical installation
- Inspecting the water installation
- Inspecting the steam installation
- Flushing the water supply line.
- Configuring the control or the Condair EL , respectively.
- Carrying out test runs including checking of the control and monitoring devices.
- Filling in the commissioning protocol.

4.2 Display and operating elements

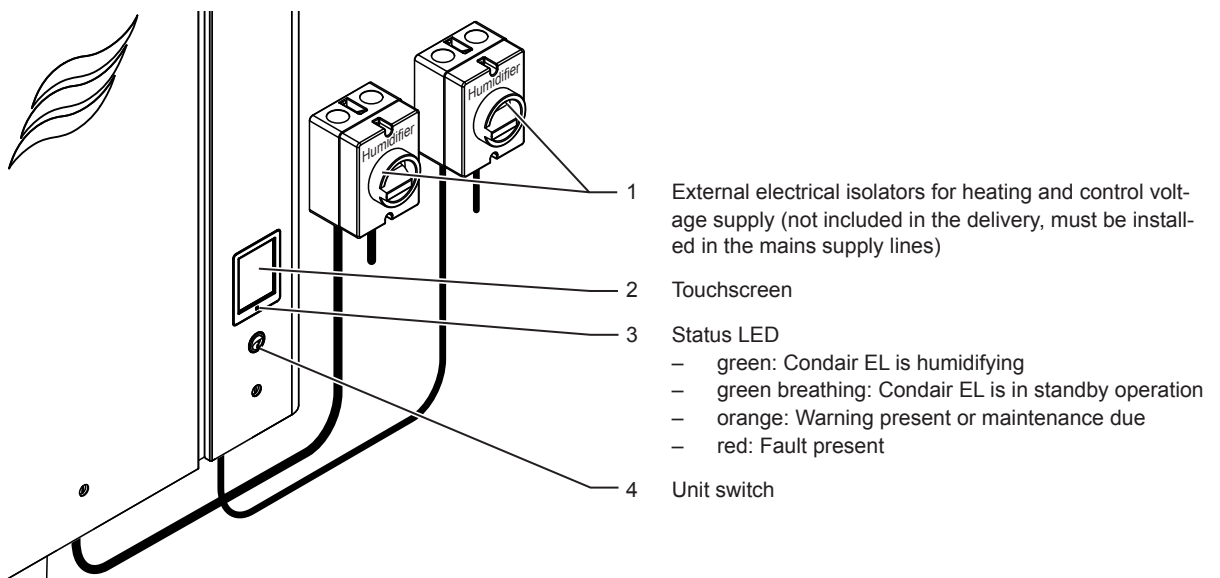

Fig. 4: Display and operating elements



DANGER!
Risk of electric shock!

After switching off the unit switch, there is still live voltage inside the control compartment of the Condair EL. **Before opening the unit, the steam humidifier must be always separated from the mains supplies (heating and control voltage) via the electrical isolators.**

4.3 Commissioning after an interruption of operation

The following description outlines the start up procedure after an interruption of operation (e.g. after servicing the steam humidifier). It is assumed that first-time commissioning has been carried out properly by the service technician of your Condair representative and the Condair EL has been configured accordingly.

1. Examine the steam humidifier and installation for possible damage.



DANGER!

A damaged unit or systems with damaged installations may present danger to human life or cause severe damage to material assets.

Therefore: Damaged systems and/or systems with damaged or faulty installations must not be operated.

2. Mount front doors of the unit and lock them (if applicable).
3. Open the filter valve (or the shut-off valve, respectively) in the water supply line.
4. Make sure the ventilation system is running and the external safety chain (e.g. ventilation interlock, air proving switch, etc.) is closed.
5. Switch on the electrical isolators in the mains supplies (heating and control voltage).
6. Switch on the unit switch of the steam humidifier.

The steam humidifier carries out an automatic system test (initialising). If a fault is detected during the system test, a corresponding fault message is shown in the maintenance and malfunction indication field (see [chapter 5.1.2](#)).

If the initialisation is successful, the Condair EL will be in **normal operating mode** and the **standard operating display** is shown.

As soon as the humidity controller or the humidistat requires humidity in excess of the minimum required system demand, the LED will change to solid green and the power for the electrodes will be activated. The inlet valve opens (slight delay) and the steam cylinder fills with water. As soon as the electrodes are submerged, heat will start to be generated depending upon the conductivity of the water. When the heat is sufficient, steam will be produced.

Note: If the Condair EL is operated with water of low conductivity, it may happen that the requested steam capacity is not reached in the first few hours of operation. This is normal. As soon as the conductivity has reached a sufficient level (due to the vaporisation process) the humidifier will reach the requested steam capacity.

4.4 Notes on operation

4.4.1 Inspections during operation

During operation the Condair EL and the humidification system have to be inspected weekly. On this occasion check the following:

- the water and steam installation for any leakage.
- the steam humidifier and the other system components for correct fixing and any damage.
- the electric installation for any damage.
- the display for possible warning or fault indication.

If the inspection reveals any irregularities (e.g. leakages, fault indication) or any damaged components take the Condair EL out of operation as described in [chapter 4.5](#). Then, contact your Condair representative.

4.4.2 Remote operating and fault indication

Via the relays on the operating and fault indication board the following operating status are indicated:

Activated remote indication relay	When?
"Error"	An error is present, operation is stopped.
"Service"	The control software has detected that the steam cylinder is spent. The unit must be serviced according to the maintenance section in this manuals (see chapter 6).
"Steam"	Demand present/humidification
"Unit on"	The humidification system is switched on and under voltage

4.4.3 Draining of the steam cylinder(s)

To perform a draining of the steam cylinder(s) proceed as follows:

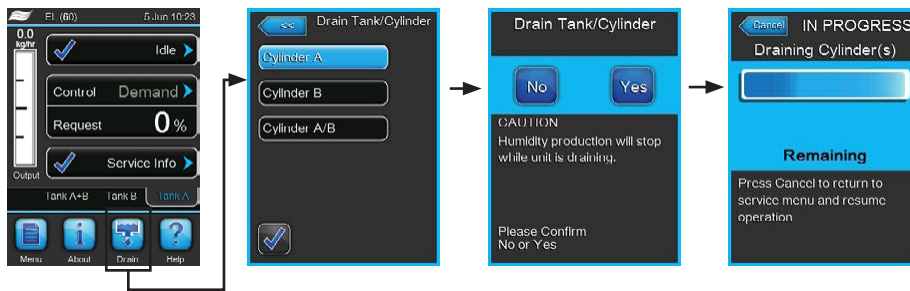

1. Press on the **<Drain>** button in the standard operating display. The "Drain Tank/Cylinder" submenu appears.
2. In the "Drain Tank/Cylinder" submenu press on the button of the cylinder(s) to be drained (**<Cylinder A>**, **<Cylinder B>** or **<Cylinder A/B>**).
Note: on single units **<Cylinder A>** button is shown only.
3. Press on the **<Yes>** button to start the draining of the steam cylinder(s). A possible running humidification process is interrupted, then the drain pump starts and empties the steam cylinder. The progress bar in the display shows the current status of the drain cycle. After draining has finished the unit returns to the "Drain Tank/Cylinder" submenu.
Note: in order to stop the drain cycle press the **<Cancel>** button in the draining progress window. The drain cycle is stopped and the unit returns to the "Drain Tank/Cylinder" submenu.
4. **If you have to carry out work on the Condair EL, switch off steam humidifier via the unit switch immediately after the countdown.** Otherwise the steam cylinder may immediately fill if there is sufficient system demand.

4.5 Taking the unit out of operation

In order to take the Condair EL steam humidifier out of operation (e.g. for maintenance purpose), perform the following steps:

1. If the unit has to be switched off because of a malfunction, please note the fault code of the actual fault message shown.
2. If you have to carry out maintenance work drain the steam cylinder via the drain function (see [chapter 4.4.3](#)).

Important: after the countdown of the cylinder draining immediately close the shut-off valve in the water supply line (step 3) and switch off steam humidifier via the unit switch (step 4).

Note: If the cylinder cannot be drained via the drain function (e.g. drain pump defective), the steam cylinder must be drained manually using the auxiliary drain hose. Prior to drain the steam cylinder manually via the auxiliary drain hose perform steps 3 to 5.



WARNING!
Danger of burning!

If steam was produced just before the unit is taken out of operation, wait and let the steam cylinder cool down before draining the cylinder via auxiliary drain hose to prevent danger of burning.

3. Close the shut-off valve in the water supply line.
4. Switch off unit switch of the steam humidifier.
5. **Disconnect steam humidifier from the mains:** Switch off both electrical isolators in the mains supply lines (heating and control voltage) and secure switches in "Off" position against accidentally being switched on, or clearly mark the switches.
6. If **ambient temperatures $\leq 0^{\circ}\text{C}$** must be expected when the steam humidifier is out of operation (operation of the Condair EL in a protective housing outside the building): drain the water supply pipe and the water filter (filter valve).



WARNING!
Danger of burning!

If steam was produced just before the unit is taken out of operation, wait before opening the unit and let the steam cylinder cool down to prevent danger of burning.

5 Operating the control software

5.1 Standard operating display

After switching on the Condair EL and the automatic system test the steam humidifier is in **normal operating** mode and the **standard operating display** is shown.

Note: the appearance of the standard operating display depends on the current operating status and the configuration of the humidity control of the system and can deviate from the display shown below.

The standard operating display is structured as follows:

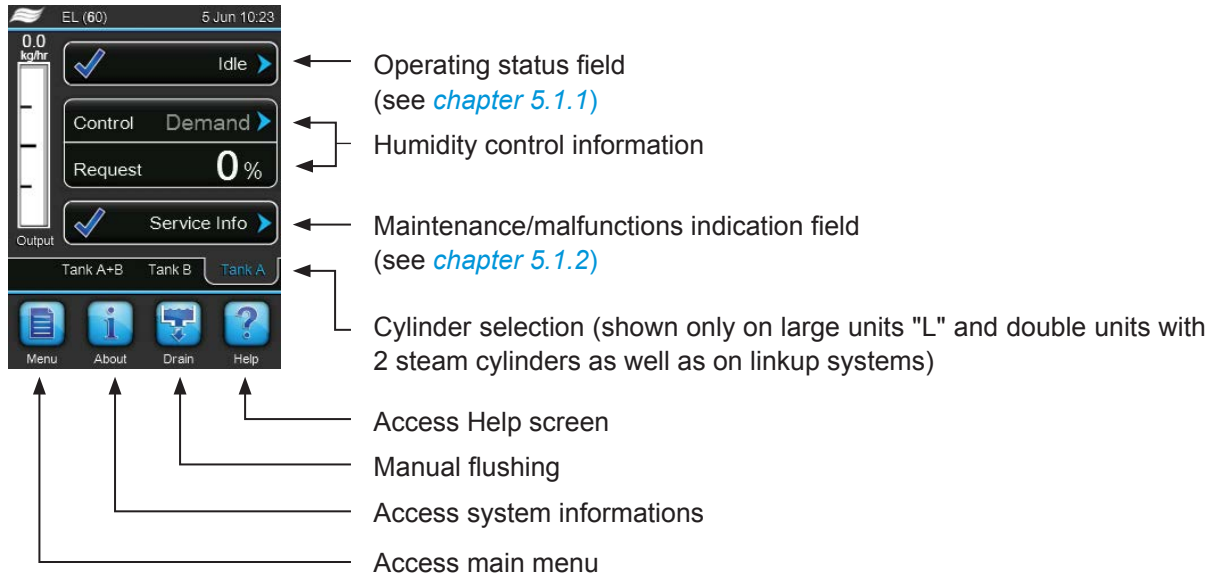



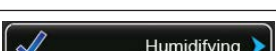
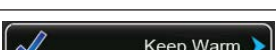



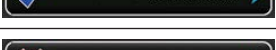

Fig. 5: Standard operating display





5.1.1 Operating status indication

The following operation status indications may appear during operation:













Operating status indication	Description
 Idle	The Condair EL is in standby mode (no demand present).
 Draining	The Condair EL is performing a cylinder flushing.
 Idle Drain	There has been no demand for humidity for an extended period of time. The humidifier idle drain function has drained the steam cylinder. The steam cylinder will automatically be refilled when humidification is required.
 Humidifying	The Condair EL is producing, or is trying to produce, steam.
 Keep Warm	The Condair EL is in standby mode and the keep warm function is activated.
 Filling	The Condair EL is filling the steam cylinder.
 Partial Drain	There has been no demand for humidity for an extended period of time. The humidifier standby partial drain function has partially drained the steam cylinder. The steam cylinder will automatically be refilled when humidification is required.
 Remote Off	The Condair EL has been stopped via an external enable contact (remote enable/disable).
 Stopped	The Condair EL is stopped due to a malfunction which prevents further operation. Additionally "Warning" or "Fault" is displayed in the maintenance and malfunction field.

5.1.2 Maintenance and malfunction indications

The following maintenance and malfunction indications may appear during operation:

Maintenance and malfunction indication	Description
 Service info	No malfunction present. By pressing on the indication field the service menu can be accessed.
 Cylinder Spent	This message appears if the control software has detected that the steam cylinder is spent. If the steam cylinder is not replaced or serviced, and the "Cylinder spent" message is not reset within 7 days, a corresponding fault message appears. Replace the steam cylinder or service the reusable cylinder, then reset the "Cylinder spent" message via the "Service" submenu.
 Warning	A malfunction with status "Warning" is active. In addition, the humidifier's yellow warning LED light will be active. Depending upon the malfunction, the Condair EL is either be stopped or stays operable for a certain period of time.
 Fault	A malfunction with status "Fault" is active. In addition, the humidifier's red error LED light will be active. The Condair EL is stopped.

5.2 Navigating/Operating the control software

Navigation element	Action
	Accessing main menu
	Accessing system informations
	Performing manual steam cylinder draining
	Accessing help screen
	If you press on a field with a blue arrow symbol a new screen with additional informations or settings appears.
	This symbol on the left side of the operating status field and of the maintenance/malfunctions indication field indicates, that the system is working ok.
	This symbol on the left side of the maintenance/malfunctions indication field indicates, that a Warning is present. Press on the field to get further information.
	This symbol on the left side of the operating status field and of the maintenance/malfunctions indication field indicates, that a Fault is present (additionally the Error LED lights red) and the humidifier stopped working. Press on the field to get further information.
	Jumps back to previous screen (Cancel and back)
	Scroll up/down in the present window
	Increase/decrease value
	Delete shown value
	Confirm set value or selected option

5.3 Information functions

5.3.1 Accessing support informations



In the standard operating display press the **<Help>** button.

The screen with the support information appears.

5.3.2 Accessing system informations



In the standard operating display press the **<About>** button.

The system information screen appears. Use the arrow buttons to scroll up and down within the system information screens to access the different system information and operating data.

General Tab



- **Humidifier Model:** Product designation.
- **Cyl. Series:** Cylinder series designation of the cylinder used in the steam humidifier.
- **Voltage:** Heating voltage range in Volts.
- **Software Version:** Actual version of the control software.



- **Driver Board A Version:** Actual software version of the driver board of unit module A.
- **Driver Board B Version:** Actual software version of the driver board of unit module B.
Note: this menu item appears only on double units or on large units with two steam cylinders.
- **Serial Number:** Serial number of the steam humidifier.
- **Graph:** With this function you can access the graphical display of the performance diagram of the Condair EL.
- **Export Trend Data:** With this function you can save the data of the performance diagram as .csv file to a USB memory stick (FAT32 formatted).
Note: before carrying this function, a FAT32 formatted USB memory stick must be connected to the USB port on the control board.

Timer Cylinder A Tab



- **On/Off Timers:** Present status of the On/Off timer function ("On": On/Off timer function activated, "Off": On/Off timer function deactivated). A warning message is displayed whenever the humidifier is turned off via the On/Off timer. For further information see [page 29](#).
- **Capacity Timers:** Present status of the timer controlled capacity limitation ("On": timer controlled capacity limitation activated, "Off": timer controlled capacity limitation deactivated). For further information see [page 28](#).
- **Setpoint Timers:** Present status of the setpoint timer function ("On": setpoint timer function activated, "Off": setpoint timer function deactivated). For further information see [page 34](#).

Service Cylinder A Tab (Service Cylinder B Tab)

Note: the tab "Service Cylinder B" appears only on double units and large units with two steam cylinders.



- **Cylinder A Installed / Cylinder B Installed:** Date of the initial commissioning or date of the last "Cylinder Spent" message reset of the steam cylinder A (or B).
- **Cylinder A Hours / Cylinder B Hours:** Operating hours of cylinder A (or B) since the last "Cylinder Spent" message reset.
- **Sensor Counter:** Counter which indicates how many times the maximum level has been reached in the steam cylinder A (or B) (determined with the maximum level sensor in the steam cylinder cover).

Operating Cylinder A Tab

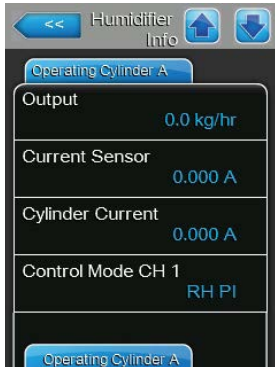

- **Output:** Actual steam output of steam cylinder A in kg/h or lb/h.
- **Current Sensor:** Actual measured current at the current sensor of unit module A in ampere (relates to the current at an electrode).
- **Cylinder Current:** Actual current of a phase (e.g. phase "L1") of unit module A.
- **Control Mode CH 1:** Actual set humidity control type ("On/Off", "Demand", "RH P" or "RH PI").

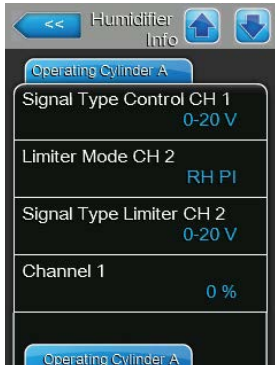

- **Signal Type Control CH 1:** Actual set humidity control signal type.
- **Limiter Mode CH 2:** Actual set limiter control type ("On/Off", "Demand", "RH P" or "RH PI").
Note: this menu item appears only if control channels mode is set to dual signal mode.
- **Signal Type Limiter CH 2:** Actual set limiter signal type.
Note: this menu item appears only if control mode is set to double signal mode.
- **Channel 1:** Actual humidity control signal in % of the maximum signal value.

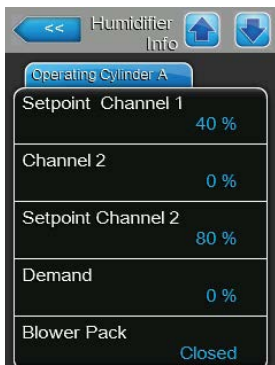

- **Setpoint Channel 1:** shows the fixed humidity setpoint value in %rh. Refer to "Setpoint Channel 1" parameter on [page 33](#) for more details.
Note: This menu item appears only if the humidity control mode is set to "RH P" or "RH PI".
- **Channel 2:** Actual limiter signal in % of the maximum signal value.
Note: this menu item appears only if Control Channels is set to "Dual".
- **Setpoint Channel 2:** shows the high limit setpoint value.
Note: this menu item appears only if Control Channels is set to "Dual" and limiter control mode is set to "RH P" or "RH PI".
- **Demand:** Actual demand in %.
- **Blower Pack:** shows the status of the blower pack A security loop (status shows "Closed" when the blower pack is connected and powered, and "Open" when it is not).
Note: When no blower pack is connected, a jumper wire must be installed in the blower pack security loop, and the status should show "Closed".

Operating Cylinder B Tab

Note: the tab "Operating Cylinder B" appears only on double units and large units with two steam cylinders.



- **Output:** Actual steam output of steam cylinder B in kg/h or lb/h.
- **Current Sensor:** Actual measured current at the current sensor of unit module B in ampere (relates to the current at an electrode).
- **Cylinder Current:** Actual current of a phase (e.g. phase "L1") of unit module B.
- **Linkup Type:** Actual set control type for the linkup system ("Series" or "Parallel"). For further information see [page 37](#).

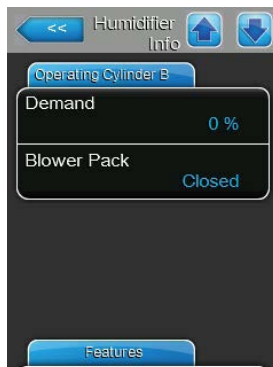

- **Demand:** Actual demand in %.
- **Blower Pack:** shows the status of the blower pack B security loop (status shows "Closed" when the blower pack is connected and powered, and "Open" when it is not).
Note: When no blower pack is connected, a jumper wire must be installed in the blower pack security loop, and the status should show "Closed".

Features Tab



- **Manual Capacity A:** Actual set capacity limitation in % of the maximum capacity. For further information see [page 28](#).
- **Low Conductivity:** Present status of the function for supply water with low conductivity ("On" or "Off").
- **Idle Mode:** Actual set standby mode ("Idle Only", "Idle Drain", "Keep Warm" or "Partial Drain").
- **Forced Drain:** Present status of the forced drain function ("On" or "Off").



- **Forced Drain Interval:** Actual set time after which a forced draining is triggered if forced drain function is enabled.
- **Short Cycle:** Present status of the short cycle function ("On" or "Off").

Network Tab

The information shown in the "Network" tab varies depending on whether a BAS (building automation system) communication protocol is enabled, and which communication protocol is selected. If no BAS protocol is enabled, then only "Online Status" and "IP Address" are shown.

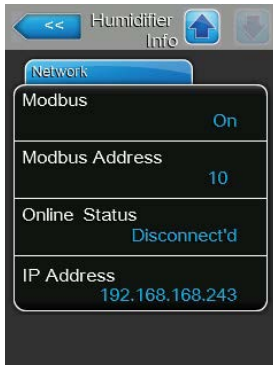

Modbus Network

- **Modbus:** shows the current status of the Modbus communications protocol. Note: This menu item appears only if the Modbus communication protocol is enabled. Refer to [Modbus Parameters Tab on page 41](#) for more details.
- **Modbus Address:** shows the Modbus address of the Condair EL. Note: This menu item appears only if the Modbus communication protocol is enabled, and the BACnet communication protocol is disabled.
- **Online Status:** shows the connection status of the Condair EL to Condair Online ("Connected" or "Disconnect'd").
- **IP Address:** shows the IP address of the Condair EL.



BACnet MSTP Network / BACnet IP Network

- **BACnet:** shows the currently selected BACnet onboard communication protocol ("MSTP" or "BACnet/IP"). Note: This field appears only if the BACnet communication protocol is enabled. Refer to [BACnet Parameters Tab on page 42](#) for more details.

BACnet MSTP Network

- **BACnet MSTP MAC:** shows the actual BACnet MSTP MAC address for the Condair EL. Note: This field appears only if "BACnet MSTP" is enabled. Refer to [BACnet Parameters Tab on page 42](#) for more details.

BACnet IP Network

- **Node ID:** shows the actual BACnet node ID for the Condair EL. Note: This field appears only if "BACnet IP" is enabled. Refer to [BACnet Parameters Tab on page 42](#) for more details.
- **Online Status:** shows the connection status of the Condair EL to Condair Online ("Connected" or "Disconnect'd").
- **IP Address:** shows the IP address of the Condair EL.



5.4 Configuration

5.4.1 Accessing the "Configuration" submenu

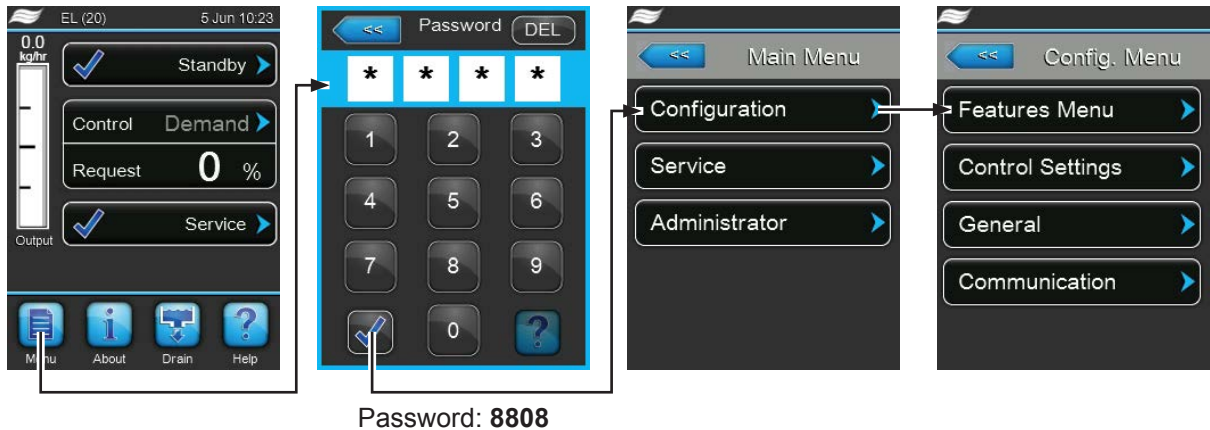

5.4.2 Determining unit settings – "Features menu" submenu

In the "Features menu" submenu you can determine different operating parameters of the Condair EL.

Water Management Tab

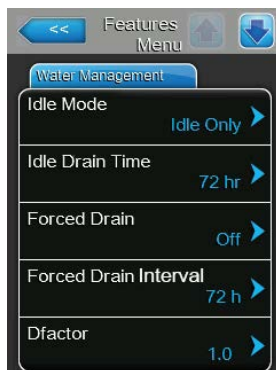

- **Idle Mode:** with this setting you determine the behaviour of the humidifier in standby operation.
 Factory setting: **Idle Only**
 Options: **Idle Only** (the cylinder is not drained in standby operation)
Idle Drain (the cylinder is completely drained after a certain time in standby operation)
Keep Warm (the water in the cylinder is kept warm via the electrodes for a certain period of time in standby operation)
Partial Drain (the cylinder is partly drained after a certain time in standby operation)
- **Idle Drain Time:** with this function you set the time duration the humidifier stays in standby mode without a demand, after which the humidifier carries out a complete drain or a partial drain of the steam cylinder.
 Note: this menu item appears only, if "Idle Mode" is set to "Idle Drain" or "Partial Drain".
 Factory setting: **72 hours**
 Setting range: **1 ... 100 hours**
- **Forced Drain:** with this function you can enable ("On") or disable ("Off") the forced drain function, which drains the steam cylinder to remove minerals every time a fixed number of running hours have passed.
 Note: Enable forced drain function when operating with water that has high conductivity.
 Factory setting: **Off**
 Options: **On** (forced draining activated)
Off (forced draining deactivated)

- **Forced Drain Interval:** with this setting you determine the period of time after which the forced cylinder draining takes place.
Factory setting: **72 hours**
Setting range: **1 ... 100 hours**
- **Dfactor:** with this setting you can increase or decrease the drain time.
Factory setting: **1.0**
Setting range: **0.2 ... 2.0**

Operation Tab



- **Manual Capacity A:** with this button you can access the capacity limit settings menu. You can set the humidifier to operate with a fixed capacity limit or via the timer function with different capacity limits.

Note: on large units with two steam cylinders and on double units the capacity limitation is valid for both steam cylinders (Module A and B). On Linkup systems the capacity limitation can be set for the main (Main module A and B) and the extension units (Extension module A and B) individually.

- Working with a **fixed capacity limit**

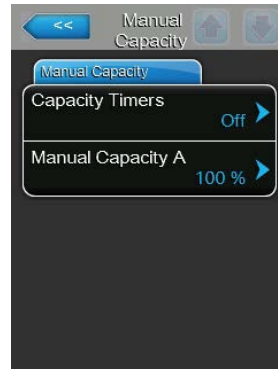

Let the timer function deactivated (Capacity Timers: "Off") or deactivate the timer function if necessary. Then, set the desired capacity limitation of the steam humidifier in % of the maximum capacity via the "Manual Capacity A" parameter (Factory setting: 100 %, Setting range: 20 ... 100 %).

- Working with **different timer controlled capacity limits**

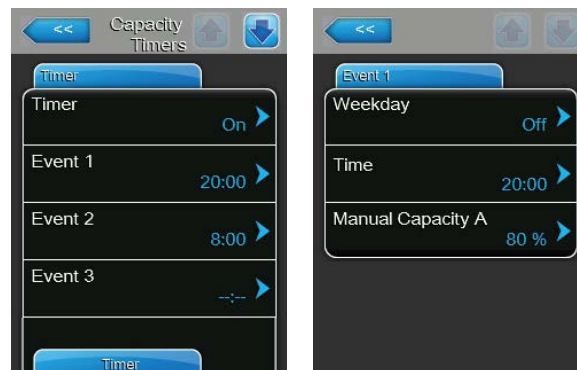

Set "Capacity Timers" setting to "ON".

If the capacity timer is activated, up to eight switching points (Event 1... Event 8) with different capacity limits can be defined. Each switching point is defined by a weekday or weekday range, the switching time and the capacity limitation in % of the maximum capacity.

Configuration notes:

- the settings of an event remain active up to the next event.
- at least two events must be configured
- the software does not check the plausibility of the timer settings. Therefore, make sure your settings make sense.
- the On/Off timer overrides the capacity limit timer.

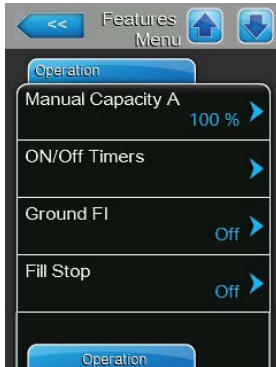

- **ON/Off Timers:** with this button you can access the settings menu for the On/Off timer.

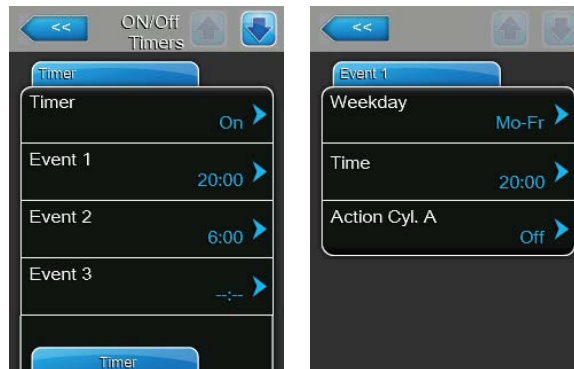

With the "Timer" parameter you can activate ("On") or deactivate ("Off") the On/Off timer.

If the timer is activated, up to eight switching points (Event 1... Event 8) with different On/Off events can be defined. Each switching point is defined by a weekday or weekday range, the switching time and the operating mode of the steam cylinder.

Configuration notes:

- the settings of an event remain active up to the next event.
- at least two events must be configured
- the software does not check the plausibility of the timer settings. Therefore, make sure your settings make sense.
- the On/Off timer overrides the capacity limit timers.



- **Ground FI:** with this setting you determine whether the main contactor will be disengaged whenever the drain pump is activated to prevent current leakage to the drain, which could trip sensitive GFI circuitry in the building ("On") or not ("Off").

Factory setting: **ON**

Options: **On** (main contactor off during draining)
Off (main contactor remains on during draining if humidifying is in progress)

- **Fill Stop:** with this setting you determine whether the inlet valve will be turned off when the heating current equals 95 % of the demand ("On") during filling to prevent overshooting the demand or not ("Off").

Note: set this setting to "On" if the supply water is of elevated conductivity.

Factory setting: **Off**

Options: **On** (inlet valve will be turned off when the heating current equals 95 % of the demand)
Off (Inlet valve remains open until 100 % of the demand is reached)



- **Low Conductivity:** this function allows you to adjust the end-of-cylinder-life detection to prevent false end-of-cylinder-life detection when conductivity of the supply water is less than 125 $\mu\text{S}/\text{cm}$.

Factory setting: **Off**

Options: **On** (use when conductivity of the supply water is less than 125 $\mu\text{S}/\text{cm}$)
Off (use when conductivity of the supply water is greater than 125 $\mu\text{S}/\text{cm}$)

- **Cyl. Type:** with this setting you determine whether the Condair EL is equipped with a replaceable steam cylinder ("Disp.") or a cleanable steam cylinder ("Clean") .

Factory setting: **Disp.**

Options: **Disp.** (replaceable steam cylinder)
Clean (cleanable steam cylinder)

Accessory Board Tab

Note: the "Accessory Board" tab with the corresponding settings appears only if the optional accessory board (for the control of an external fan of the ventilation system or the optional valve for flushing the water supply line) is installed.



- **Fan On:** with this setting you can activate ("On") or deactivate ("Off") the control of an external fan via the corresponding relay on the optional accessory board.

Factory setting: **Off**

Options: **Off or On**

The following setting appears only if the function "Fan On" is activated ("On").

- **Fan Delay:** with this setting you determine the desired follow-up time of the external fan in seconds.

Note: the follow-up time serves to remove humidity out of the duct due to post-steaming of the steam humidifier.

Factory setting: **60 seconds**

Setting range: **0 ... 300 seconds**

- **Hygiene Flush:** with this setting you can activate ("On") or deactivate ("Off") the control of the optional water supply line flushing valve in standby operation via the corresponding relay on the optional accessory board.

Factory setting: **Off**

Options: **Off or On**

The following settings appear only if the function "Hygiene Flush" is activated ("On").

- **Hygiene Flush Interval:** with this setting you determine after which time in standby mode, the water supply line shall be flushed.

Factory setting: **24 hours**

Setting range: **1 ... 999 hours**

- **Hygiene Flush Time:** with this setting you determine how long the water supply line shall be flushed.

Factory setting: **5 seconds**

Setting range: **1 ... 3600 seconds**

5.4.3 Humidity control Settings – "Control Settings" submenu

In the "Control Settings" submenu you determine the control settings for the Condair EL steam humidifier. The control settings available depend on the selected signal source and the control mode as well as whether the steam humidifier is controlled with supply air limitation.

Basic Tab



- **Source:** with this setting you determine the source of the control signal.
Factory setting: **Analog**
Options: **Analog** (Analog Sensor/humidity controller signal)
Modbus (Modbus signal)
BACnet/IP (Signal via BACnet/IP)
BACnet/MS (Signal via BACnet MSTP)
LonWorks (Signal via LonWorks)
- **Control Mode CH 1:** with this setting you determine the type of controller used for the humidity control input of the Condair EL.
Factory setting: **Demand**
Options: **On/Off** (external On/Off humidistat)
Demand (external continuous controller)
RH P (internal P controller)
RH PI (internal PI controller)
- **Limiter Mode CH 2:** with this setting you determine the type of controller used for the supply air limitation control input of the Condair EL.
Note: this setting appears only if "Control Channels" is set to "Dual".
Factory setting: **Demand**
Options: **On/Off** (external On/Off humidistat)
Demand (external continuous controller)
RH P (internal P controller)
RH PI (internal PI controller)
- **Control Channels:** with this setting you determine, whether the steam humidifier is controlled without supply air limitation (set to "Single") or with supply air limitation (set to "Dual").
Factory setting: **Single**
Options: **Single** (without supply air limitation) or
Dual (with supply air limitation)



- **Signal Type Control CH 1:** with this setting you determine the control signal type the Condair EL is controlled with.
Note: this setting appears only if signal source is set to "Analog" and "Control Mode CH 1" is set to "Demand", "RH P" or "RH PI".

Factory setting: **0-10 V**
Options: **0-5 V, 1-5 V, 0-10 V, 2-10 V, 0-20 V, 0-16 V, 3.2-16 V, 0-20 mA, 4-20 mA**

- **Signal Type Limiter CH 2:** with this setting you determine the limiter signal type (supply air limitation) the Condair EL is controlled with.
Note: this setting appears only if signal source is set to "Analog", "Limiter Mode CH 2" is set to "Demand", "RH P" or "RH PI" and Control Channels is set to "Dual".

Factory setting: **0-10 V**
Options: **0-5 V, 1-5 V, 0-10 V, 2-10 V, 0-20 V, 0-16 V, 3.2-16 V, 0-20 mA, 4-20 mA**

PI Control Parameters Tab



- **Setpoint Channel 1:** with this button you can access the settings menu for the humidity setpoint. Here you determine whether the Condair EL is to be controlled with a fixed humidity setpoint (factory setting) or whether it is to be operated timer controlled with different humidity setpoints.
Note: this menu item appears only if "Control Mode CH 1" is set to "RH P" or "RH PI".

- Control with **fixed humidity setpoint**



Let the timer function deactivated ("Setpoint Timers: **Off**") or deactivate the timer function if necessary. Then, set the desired humidity setpoint value in %RH via the "Setpoint Channel 1" parameter (Factory setting: **40 %rh**, Setting range: **0...95 %rh**).

– Operation with **timer controlled capacity limitation**

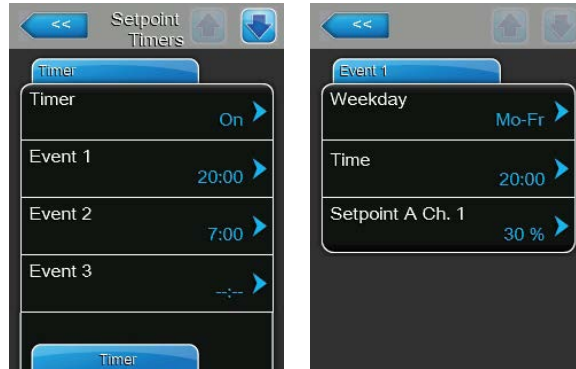

Activate the timer function ("Setpoint Timers: **On**"). If the setpoint timer is activated, up to eight switching points (Event 1... Event 8) with different humidity setpoints can be defined. Each switching point is defined by a weekday or weekday range, the switching time and the humidity setpoint in %rh.

Configuration notes:

- the settings of an event remain active up to the next event.
- at least two events must be configured
- the software does not check the plausibility of the timer settings. Therefore, make sure your settings make sense.
- the On/Off timer overrides the humidity setpoint timer.



- **Band Channel 1:** with this setting you set the proportional range for the internal P/PI controller in %rh.

Note: this setting appears only if "Control Mode CH 1" is set to "RH P" or "RH PI".

Factory setting: **15 %**
 Setting range: **6 ... 65 %**

- **ITime Channel 1:** with this setting you set the integral time for the internal P/PI humidity controller.

Note: this setting appears only if "Control Mode CH 1" is set to "RH PI".

Factory setting: **5 minutes**
 Setting range: **1 ... 60 minutes**

- **Setpoint Channel 2:** with this setting you set the humidity setpoint for the internal P/PI supply air controller in %rh.

Note: this setting appears only if "Limiter Mode CH 2" is set to "RH P" or "RH PI" and "Control Channels" is set to "Dual".

Factory setting: **80 %**
 Setting range: **0 ... 95 %**



- **Band Channel 2:** with this setting you set the proportional range for the internal P/PI supply air controller in %rh.
Note: this setting appears only if "Limiter Mode CH 2" is set to "RH P" or "RH PI" and "Control Channels" is set to "Dual".
Factory setting: **15 %**
Setting range: **6 ... 65 %**
- **Damp Channel 2:** with this setting you set the time in seconds after which the supply air controller takes over the control of the demand signal.
Note: this setting appears only if "Limiter Mode CH 2" is set to "RH P" or "RH PI" and "Control Channels" is set to "Dual".
Factory setting: **5 seconds**
Setting range: **1 ... 60 seconds**

RH Alerts Tab

Note: The "RH Alerts" settings appear only if the internal P or PI controller is activated.



- **RH Alerts:** with this setting you can enable ("On") or disable ("Off") the alert function that triggers a warning if sensed humidity is too high or too low.

Factory setting: **Off**

Options: **On or Off**

The following three settings appear only if "RH Alerts" function is activated ("On").

- **RH High:** with this setting you set the upper limit value in per cent of the maximum signal value of the humidity sensor, if exceeded a RH High warning message is triggered.

Factory setting: **75 %**

Setting range: **20 ... 95 %**

- **RH Low:** with this setting you set the lower limit value in per cent of the maximum signal value of the humidity sensor, if undershot a RH Low warning message is triggered.

Factory setting: **20 %**

Setting range: **20 ... 95 %**

- **Sensor Min:** with this setting you set the minimum signal value in per cent of the maximum signal value of the humidity sensor, if undershot a sensor interruption message is triggered.

Factory setting: **5 %**

Setting range: **1 ... 10 %**

- **Enable Input:** with this function you can enable ("On") or disable ("Off") steam production using an external contact connected to terminal X11 on the driver board. When set to On, steam production will not be allowed unless the contact connected to terminal X11 on the driver board is closed.

Factory setting: **Off**

Options: **On or Off**

Multi Unit Operation Tab



- **Dual Cylinder Mode:** With this setting you determine the control type for double cylinder units.

Note: this setting appears only on double cylinder units.

Factory setting: **Series**

Options: **Parallel** (even distribution of the demand on both cylinders)

Series (serial distribution of the demand, first the first cylinder is regulated up to its max. capacity, then with further rising demand the second cylinder is regulated up to its max. capacity)

- **Linkup:** with this setting you determine whether the unit is part of a Linkup system and acts as "Main" or "Extension" unit or whether the unit is not part of a Linkup system.

Note: the main unit must be set always to "Main". The further extension units in the chain must be set in ascending order to "Ext1" to "Ext5".

Factory setting: **Off**

Options: **Off** (no Linkup system)

Main (Main unit of the Linkup system)

Ext1 (first extension unit of the Linkup system)

Ext2 (second extension unit of the Linkup system)

Ext3 (third extension unit of the Linkup system)

Ext4 (fourth extension unit of the Linkup system)

Ext5 (fifth extension unit of the Linkup system)

The following menu items appear only if "Linkup" is set to "Main".



- **Linkup Units:** with this setting you determine the number of units belonging to the linkup system.

Factory setting: **1**

Setting range: **1 ... 6**

- **Linkup Type:** With this setting you determine how the total system demand is to be divided amongst the individual units of the linkup system

Factory setting: **Series**

Options: **Parallel** (even distribution of the demand on the units)
Series (serial distribution, first "Main" up to 100 %, then "Ext1" up to 100 %, then "Ext2" up to 100 %, etc.)

- **Sequence Rotation:** with this setting you determine whether the cylinder with the lowest number of operating hours is started first ("On") or not ("Off") if serial distribution of the demand is activated

Note: this setting appears only, if "Linkup Type" is set to "Series".

Factory setting: **On**

Options: **On or Off**

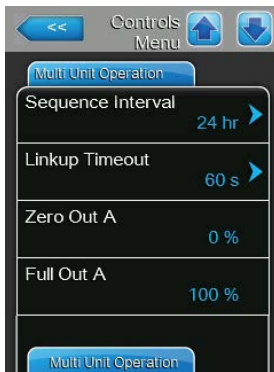

- **Sequence Interval:** with this setting you determine the interval time the control system compares the operating hours of the cylinders in order to change the starting order if sequential cylinder rotation activated.
Note: this setting appears only, if the "Sequence Rotation" function is activated ("On").

Factory setting: **24 hours**
 Setting range: **24 ... 1000 hours**

- **Linkup Timeout:** with this setting you determine, how long the units of a linkup systems can operate without connection among each other, before an error message is triggered.

Factory setting: **60 seconds**
 Setting range: **60 ... 120 seconds**

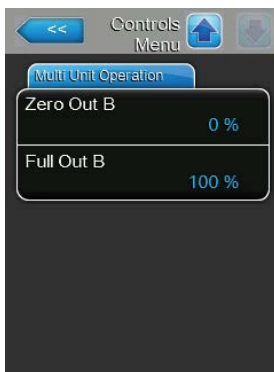

The following menu items appear only if "Linkup" is set to "Main", "Ext1", "Ext2", "Ext3", "Ext4" or "Ext5".

- **Zero Out A:** this parameter indicates at which percentage of the demand signal cylinder A is switched on (calculated value).
- **Full Out A:** this parameter indicates at which percentage of the demand signal cylinder A achieves 100% demand (calculated value).
- **Zero Out B:** this parameter indicates at which percentage of the demand signal cylinder B is switched on (calculated value).
- **Full Out B:** this parameter indicates at which percentage of the demand signal cylinder B achieves 100% demand (calculated value).

5.4.4 Basic settings – "General" submenu

In the "General" submenu you determine the basic settings for operating the Condair EL control software.

Basic Tab

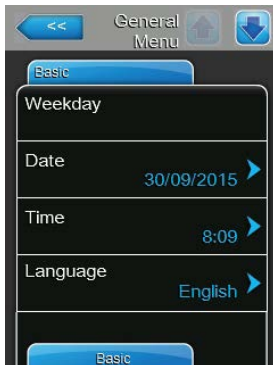

- **Date:** with this setting you set the current date in the set format ("MM/DD/YYYY" or "DD/MM/YYYY", see [date and clock format settings below](#)).
- **Time:** with this setting you set the current hour of the day in the set time format ("12H" or "24H").
- **Language:** with this setting you determine the dialogue language.
Factory setting: **depending on the country**
Options: **various dialogue languages**



- **Units:** with this setting you determine the desired unit system.
Factory setting: **depending on the country**
Options: **Metric or Imperial**
- **Contrast:** with this setting you determine the desired value for the display contrast.
Factory setting: **8**
Options: **1 (weak contrast) ... 31 (strong contrast)**
- **Brightness:** with this setting you determine the desired value for the display brightness.
Factory setting: **52**
Options: **1 (dark) ... 100 (white)**
- **LED Brightness:** with this setting you determine the desired value for the brightness of the operation indication LED.
Factory setting: **52**
Options: **1 (weak) ... 100 (bright)**

Time/Date Tab



- **Date Format:** With this setting you determine the desired date format.
Factory setting: **DD/MM/YYYY**
Options: **DD/MM/YYYY or MM/DD/YYYY**
- **Clock Format:** With this setting you determine the desired time format.
Factory setting: **12H**
Options: **24H** (24 hours, display 13:35) or **12H** (12 hours, display: 01:35 PM)

5.4.5 Communication settings – "Communication" submenu

In the "Communication" submenu you determine the parameters for digital communication protocols.

Remote Enable Tab

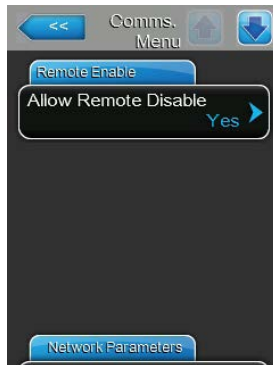

- **Allow Remote Disable:** with this setting you can activate ("Yes") or deactivate ("No") remote blocking via the BMS.

Factory setting: **Yes**

Options: **Yes** (Remote blocking permitted)
No (Remote blocking not permitted)

Network Parameters Tab



The following network settings are used only for the communication via the integrated BACnet IP interface.

- **IP Type:** with this setting you determine whether you want to assign the IP Address, the Subnet Mask, the Standard Gateway as well as the Primary and Secondary DNS address as fixed values or whether these should be dynamically assigned via a DHCP server.

Note: after 5 unsuccessful attempts at obtaining an address with DHCP the system will revert to fixed assignment

Factory setting: **DHCP**

Options: **DHCP** (dynamic assignment)
Fixed (fixed assignment)

- **IP Address:** with this setting you manually enter the IP Address of the Condair EL.

Note: This IP Address is used if "IP Type" is set (or reverts) to "Fixed".

- **Subnet Mask:** with this setting you determine the Subnet Mask of the IP network.

Note: This Subnet Mask is used if "IP Type" is set (or reverts) to "Fixed".

- **Default Gateway:** with this setting you determine the IP Address of the Default Gateway.

Note: This IP Address for the Default Gateway is used if "IP Type" is set (or reverts) to "Fixed".

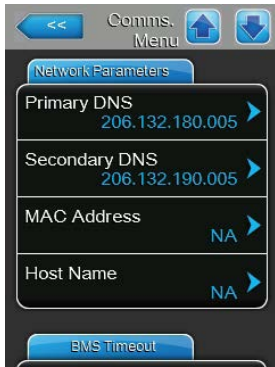

- **Primary DNS:** with this setting you determine the IP Address of the Primary Domain Name Server (DNS).
Note: This IP Address for the Primary Domain Name Server is used if "IP Type" is set (or reverts) to "Fixed".
- **Secondary DNS:** with this setting you determine the IP Address of the Secondary Domain Name Server (DNS).
Note: This IP Address for the Secondary Domain Name Server is used if "IP Type" is set (or reverts) to "Fixed".
- **MAC Address:** with this setting you determine the MAC Address (Media Access Control Address) of the Condair EL.
- **Host Name:** with this setting you determine the Host Name of the Condair EL.

BMS Timeout Tab

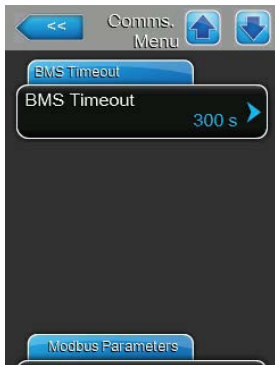

- **BMS Timeout:** with this setting you determine the maximum time the humidifier will wait with no communication from the BMS network before a BMS timeout warning is generated. Exceeding the timeout also stops humidifier operation if the signal source of the humidifier is set to a BMS input.
Factory setting: **300 s**
Setting range: **1 ... 300 s**

Modbus Parameters Tab

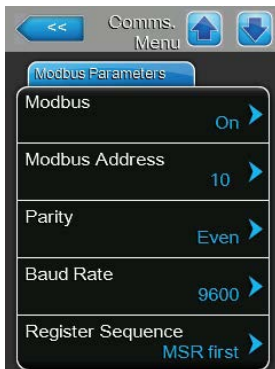

- **Modbus:** with this setting you can activate ("On") or deactivate ("Off") communication via a Modbus network.
Note: in order to activate the setting of this parameter the Condair EL must be switched off and on again.
Factory setting: **Off**
Options: **Off or On**

The following parameters appear only if the Modbus function is activated.

- **Modbus Address:** with this setting you determine the Modbus address for the Condair EL for the communication via a Modbus network.
Factory setting: **10**
Setting range: **1 ... 247**
- **Parity:** with this setting you set the parity bit for the data transfer.
Factory setting: **Even**
Options: **None, Even or Odd**
- **Baudrate:** with this setting you set the Baudrate for the data transfer.
Factory setting: **9600**
Options: **110, 300, 600, 1200, 2400, 4800, 9600, 19200, 38400, 57600, 76800 or 115200**

- **Register Sequence:** with Modbus communication 32 Bit floating-point numbers are transmitted in two registers of 16 Bit each. In order that sender and receiver understand each other (that means both use the identical partitioning of the 32 Bit to the two 16 Bit registers) it must be determined whether the high-order register (MSR = Most Significant Register) or the low-order register (LSR = Least Significant Register) is transmitted first. With this setting you determine which register is transmitted first when transmitting floating-point numbers.

Factory setting: **LSR first**

Options: **LSR first** (low-order register is transmitted first)
MSR first (high-order register is transmitted first)

BACnet Parameters Tab



- **BACnet:** with this setting you can activate ("MSTP" or "BACnet/IP") or deactivate ("Off") the communication via the integrated BACnet interface. Note: in order to activate the setting of this parameter the Condair EL must be switched off and on again.

Factory setting: **Off**

Options: **Off** (BACnet interface deactivated)
MSTP (BACnet MSTP via RS 485 interface, Note: the Condair EL is a slave-only BACnet MSTP device)
BACnet/IP (BACnet/IP via RJ45 interface)



The following settings appear only, if the parameter "BACnet" is set to "BACnet/IP".

- **Device Name:** with this setting you determine the name of the Condair EL for the communication via the integrated BACnet interface.
- **Device Description:** with this setting you determine a short description of the unit.
- **Device Location:** with this setting you determine the designation of the unit location.

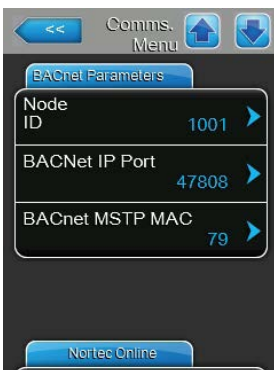

- **Node ID:** with this setting you assign a node ID to the Condair EL for the communication via the BACnet/IP protocol.

Factory setting: **1001**
 Setting range: **1-9999999**

- **BACnet IP Port:** with this setting you assign a IP port number for the Condair EL.

Factory setting: **47808**
 Setting range: **1-65535**

- **BACnet MSTP MAC:** with this setting you assign a MSTP MAC address for the Condair EL.

Factory setting: **128**
 Setting range: **128-254**



Remote Fault Board Tab



The following settings appear only, if the parameter "BACnet" is set to "MSTP".

Note: with BACnet MSTP the Condair EL acts as a slave node only device.

- **Parity:** with this setting you set the parity bit for the data transfer.
 Factory setting: **Even**
 Options: **None, Even or Odd**
- **Baudrate:** with this setting you set the Baudrate for the data transfer.
 Factory setting: **9600**
 Options: **110, 300, 600, 1200, 2400, 4800, 9600, 19200, 38400, 57600, 76800 or 115200**
- **Device Name:** with this setting you determine the name of the Condair EL for the communication via the integrated BACnet interface.
- **Device Description:** with this setting you determine a short description of the unit.
- **Device Location:** with this setting you determine the designation of the unit location.
- **Node ID:** with this setting you assign a node ID to the Condair EL for the communication via the BACnet/MSTP/IP protocol.
 Factory setting: **1001**
 Setting range: **1-9999999**
- **BACnet IP Port:** with this setting you assign a IP port number for the Condair EL.
 Factory setting: **47808**
 Setting range: **1-65535**
- **BACnet MSTP MAC:** with this setting you assign a MSTP MAC address for the Condair EL.
 Factory setting: **128**
 Setting range: **128-254**

- **Indication:** with this setting you determine whether only maintenance messages ("Service") or all Warning messages ("Warning") are outputted via the service relay of the remote operating and fault indication board.
 Factory setting: **Service**
 Options: **Service or Warning**
- **Safety Loop:** with this setting you determine whether the service relay on the remote operating and fault indication board is activated when the external safety chain is open ("Yes") or not ("No").
 Factory setting: **No**
 Options: **No or Yes**

5.5 Maintenance functions

5.5.1 Accessing the "Service" submenu

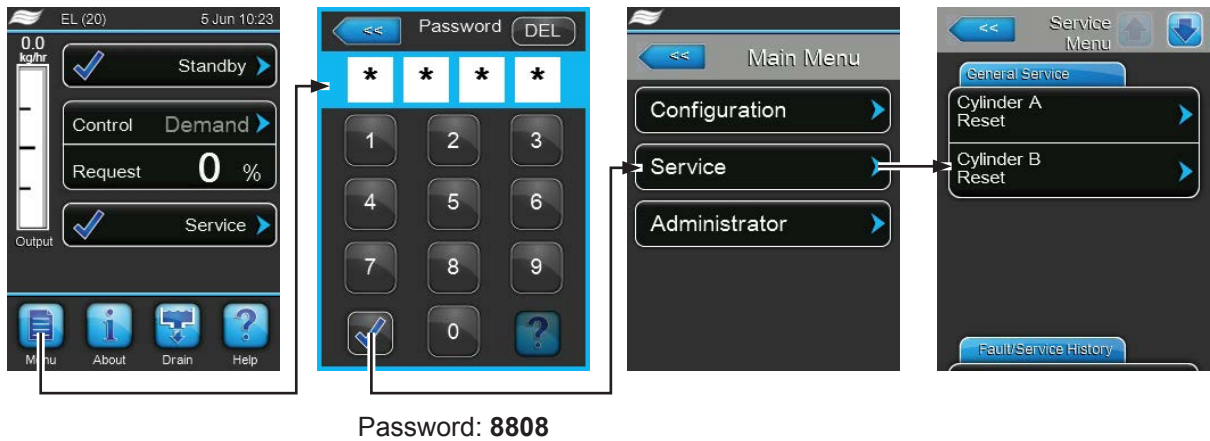

5.5.2 Performing maintenance functions – "Service" submenu

In the "Service" submenu you can reset the maintenance counters, access the fault and maintenance history and perform different diagnostic functions.

General Service Tab



- **Cylinder A Reset:** with the "Cylinder A Reset" function you can reset the service message or the service counter, respectively for the maintenance of unit A. After pressing on the "Cylinder A Reset" button a confirmation window appears where the resetting must be confirmed.
- **Cylinder B Reset:** with the "Cylinder B Reset" function you can reset the service message or the service counter, respectively for the maintenance of unit A. After pressing on the "Cylinder B Reset" button a confirmation window appears where the resetting must be confirmed.
Note: this menu item appears only on double units and large units with two steam cylinders.

Fault/Service History Tab



Note: the fault and maintenance events stored can be correctly analysed only if the data and the time of day are correctly set.

- **Fault History:** with this function you can access the fault history list where the last 40 fault events are stored. After pressing on the "Fault History" button the fault history list appears.
- **Service History:** with this function you can access the service history list where the last 40 service events are stored. After pressing on the "Service History" button the service history list appears.
- **Export History:** with the function "Export History" you can export the fault and service history list to a FAT32 formatted USB memory stick via the USB port on the control board. Detailed information can be found in [chapter 7.3](#).

Diagnostics Tab



- **Input Diagnostics:** with this function you can access the "Input Diagnostics" submenu where you can view different current input values the control system is using. Detailed information can be found in [chapter 5.5.2.1](#).
- **Relay Diagnostics:** with this function you can access the "Relay Diagnostics" submenu where you can activate or deactivate the relays of the optional remote operating and fault indication board and the optional accessory board. Detailed information on the individual relay diagnostic functions can be found in [chapter 5.5.2.2](#).

Note: By accessing the "Relay Diagnostics" submenu the humidification system is automatically switched to standby operation.

5.5.2.1 Input diagnostic functions – "Input Diagnostics" submenu

The following input values can be viewed after accessing the "Input Diagnostics" submenu.

Note: the input values can be accessed and viewed too, via the "Service Info" selection field in the standard operating display.

Cylinder A Tab (Cylinder B Tab)

Note: the tabs of the input diagnostics for Cylinder B appear only on double units or large units with two steam cylinders.

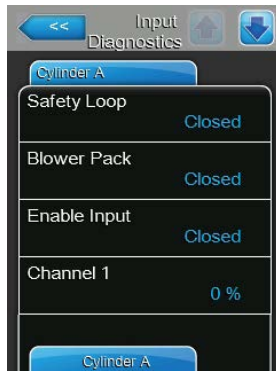

- **Safety Loop:** Present status of the external safety chain ("Open"= safety chain open, "Closed"= safety chain closed).
- **Blower Pack:** Actual status of blower pack safety loop connected to blower pack input pins on driver board ("Open"= Blower pack safety loop is open, blower pack does not have power to it and the humidifier is stopped, "Closed"= Blower pack safety loop is closed, blower pack starts running as soon as the humidifier produced steam).
- **Enable Input:** Actual status of the external enable switch, if present ("Open"= switch open, "Closed"= switch closed).
- **Channel 1:** Humidity control signal in % of its maximum value.



- **Channel 2:** Limiter signal in % of its max. value.
- **Aux. Level Sensor:** This function is not supported.
- **High Water Sensor:** Present level in the steam cylinder detected by the maximum level sensor ("Off"= water level in steam cylinder not at maximum level, "On"= water level in steam cylinder at maximum level).
- **Current Sensor:** Actual heating current in amps.



- **Run Time:** Operating hours since initial commissioning.
- **Event Counter:** this parameter shows the number of power cycle every time the user has power cycled the humidifier to change CXF (CXF = Cylinder x fault) back to CXW (CXW = Cylinder x warning).
- **Cycle Counter:** this parameter shows how many times the humidifier has gone from an idle state (not producing steam) to active operation state (with valid demand). Idle states include, safety loop open state, blower pack open, any of the four idle modes in software, remote disable, etc.

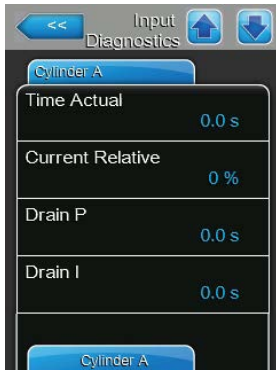

- **Time Actual:** this parameter shows the measured time in seconds for the current draw to decrease across predetermined thresholds during the last evaporation cycle.
- **Current Relative:** this parameter shows the present percentage of current draw (amps) being observed for the cylinder relative to the current required to satisfy the demand.
- **Drain P:** this parameter shows the proportional drain time calculated based upon the last boil down cycle.
- **Drain I:** this parameter shows the integral drain time calculated based upon the trended boil down cycles.



- **Drain Time:** this parameter shows the time calculated for the last demineralization drain.
- **Drain Sum:** this parameter shows the sum of the proportional drain time, integral drain time, and drain time accumulator that results in a total time for the next demineralization drain.

5.5.2.2 Relay diagnostic functions – "Relay Diagnostics" submenu

Remote Fault Board Tab

Note: when you leave this menu, the function of the relays will revert to automated operation.

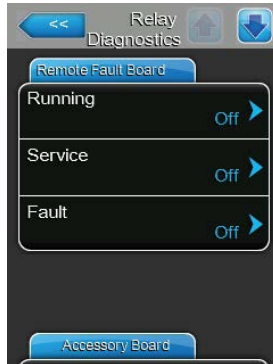

- **Running:** with this function you can activate ("On") and deactivate ("Off") the relay "Steam" on the remote operation and fault indication board.
- **Service:** with this function you can activate ("On") and deactivate ("Off") the relay "Service" on the remote operation and fault indication board.
- **Fault:** with this function you can activate ("On") and deactivate ("Off") the relay "Error" on the remote operation and fault indication board.

Accessory Board Tab

Note: when you leave this menu, the function of the relays will revert to automated operation.



- **Fan Activate A:** with this function you can activate ("On") and deactivate ("Off") an external fan of the AHU connected to module A via the relay "FAN A" on the accessory board.
- **Flush A:** with this function you can activate ("On") and deactivate ("Off") the optional valve for flushing the water supply line of module A via the relay "Hyg. Valve A" on the accessory board.
- **Fan Activate B:** with this function you can activate ("On") and deactivate ("Off") an external fan of the AHU connected to module B via the relay "FAN B" on the accessory board.
- **Flush B:** with this function you can activate ("On") and deactivate ("Off") the optional valve for flushing the water supply line of module A via the relay "Hyg. Valve B" on the accessory board.

5.6 Administration settings

5.6.1 Accessing "Administrator" submenu



Password: 8808

5.6.2 Switching on/off password protection and software updates function - submenu "Administrator"

In the "Administrator" submenu you can activate and deactivate the password protection for the main menu and the setpoint, and download software updates via a USB stick connected to the USB connector.

Password Settings Tab

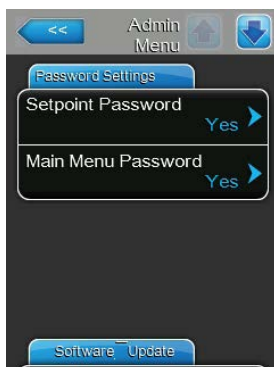

- **Setpoint Password:** with the function "Setpoint Password" you can protect the setpoint input screen with the user password "8808" against unauthorised access ("Yes") or not ("No").
- **Main Menu Password:** with the function "Main Menu Password" you can protect the access to the main menu with the user password "8808" against unauthorised access ("Yes") or not ("No")

Software Update Tab



- **Software Update:** with this function you can update the control software of the integrated controller. See information in [chapter 6.7](#).
- **Driver Board A.DB.A:** with this function you can update the driver board software of steam humidifier A. See information in [chapter 6.7](#).
- **Driver Board A.DB.B Update:** with this function you can update the driver board software of steam humidifier B. See information in [chapter 6.7](#).

Software Settings Tab



- **Load Contact Info Page:** this function allows you to upload new contact information data (which are displayed when pressing the <Help> button) from a USB memory stick connected to the USB port on the control board.
- **Manually Load Contact Info:** this function allows you to manually change/enter contact information data (which are displayed when pressing the <Help> button).
- **Load Logger Definition:** this function allows logging of system parameters with a FAT32 formatted USB memory stick connected to the USB port on the control board. A factory supplied access file is required to enable operation.

6 Maintenance

6.1 Important notes on maintenance

Qualification of personnel

All maintenance work must be carried out only by **well qualified and trained personnel authorised by the owner**. It is the owner's responsibility to verify and define proper qualification of the personnel.

General note

The instructions and details for maintenance work must be followed and upheld.

Only the maintenance work described in this documentation may be carried out.

Only use original Condair spare parts to replace faulty parts.

Safety

Some maintenance work requires removal of the unit covers. Please note the following:



DANGER!
Danger of electric hazard!

You may get in touch with live parts when the unit is open. Touching live parts may cause severe injury or even lethal violation.

Prevention: Before carrying out any maintenance work set the Condair EL out of operation as described in [chapter 4.5](#) (switch off the unit, disconnect it from the mains and stop the water supply) and secure the unit against inadvertent power-up.



CAUTION!

The electronic components inside the humidifier are very sensitive to electrostatic discharge.

Prevention: Before carrying out any maintenance work to the electrical or electronic equipment of the humidifier, appropriate measures must be taken to protect the respective components against damage caused by electrostatic discharge (ESD protection).



WARNING!
Danger of burning!

The water in the steam cylinder and in the scale collector tank can be hot (up to 95 °C). There is danger of burning when the steam cylinder(s) and the scale collector tank(s) is/are dismantled shortly after steam has been produced.

Prevention: Before carrying out any work on the steam system set the Condair EL out of operation as described in [chapter 4.5](#), then wait until the components have cooled down sufficiently (see temperature indication adhesive on the scale collector tank) thus preventing danger of burning.

6.2 Maintenance intervals

To maintain operational safety the Condair EL steam humidifier must be maintained at regular intervals. This is differentiated between the **regular replacement/cleaning of the steam cylinder** and the **periodic maintenance of the steam humidifier**.

– **Replacement of the disposable steam cylinder/Cleaning of the cleanable steam cylinder**

The control software of the Condair EL monitors the performance of the steam cylinder and indicates when replacement/cleaning of the steam cylinder is required. The steam cylinder status is set to initial state at the initial commissioning and any time the steam cylinder is reset via the cylinder reset function the "Service" submenu.



The "Cylinder Spent" message in the standard operating display indicates that the steam cylinder must be replaced (disposable steam cylinder) or cleaned (cleanable steam cylinder). If the maintenance is not carried out and the cylinder status is not reset within 7 days after the "Cylinder Spent" message has appeared a fault message is triggered and the steam humidifier will be stopped.

Replace/clean the steam cylinder, then reset the cylinder status to initial state with the cylinder reset function in the "Service" submenu.

Note: For the replacement/cleaning of the steam cylinder, corresponding maintenance kits are available with all components to be replaced with the corresponding steam cylinder maintenance.

– **Periodic maintenance**

The periodic maintenance **is to be carried out at least once a year**. If on this occasion strong contamination is detected, the interval time for the periodic maintenance must be shortened accordingly. Below you will find a summary of the work to be carried out at the periodic maintenance.

Components	Work to be done
Drain pump	Remove, disassemble and clean, replace if necessary.
Steam cylinder receptacle	Inspect, clean if necessary.
Inlet valve	Remove and clean filter insert, replace if necessary.
Fill cup	Remove and clean if necessary
Drain cup	Remove and clean if necessary
Drain pipe and siphon	Inspect, clean if necessary (decalcify and rinse out).
Steam installation	Inspect steam and condensate hoses for cracks and to see that they are correctly attached, replace faulty hoses.
Water installation	Inspect water hoses in the unit for cracks and to see that they are correctly attached, replace faulty hoses. Check supply pipe is tight, make tight if necessary. Clean water filter, if available.
Electrical installation	Check all cables in the unit are firmly positioned and examine status of insulation.

6.3 Removing and installing components for maintenance

6.3.1 Removal and installation of the steam cylinder



WARNING!
Danger of burning!

Before removal of the steam cylinder ensure the steam cylinder is empty and has cooled down, that no more burning danger exists.

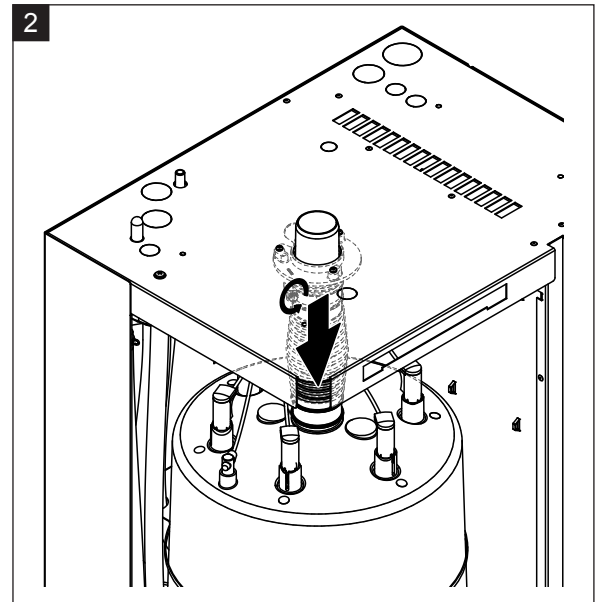
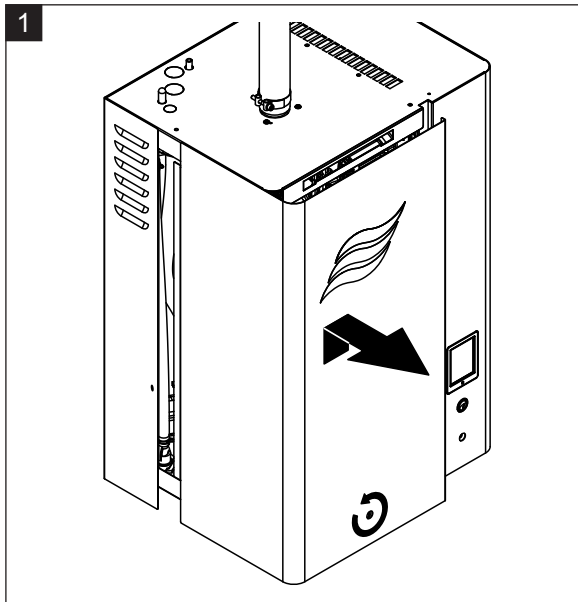

1. Loosen retaining screw of the front door on the steam cylinder side of the unit using a screwdriver, then remove the front door.
2. Free the upper hose clamp of the steam outlet hose using a screwdriver and pull the hose downwards from the steam connector.

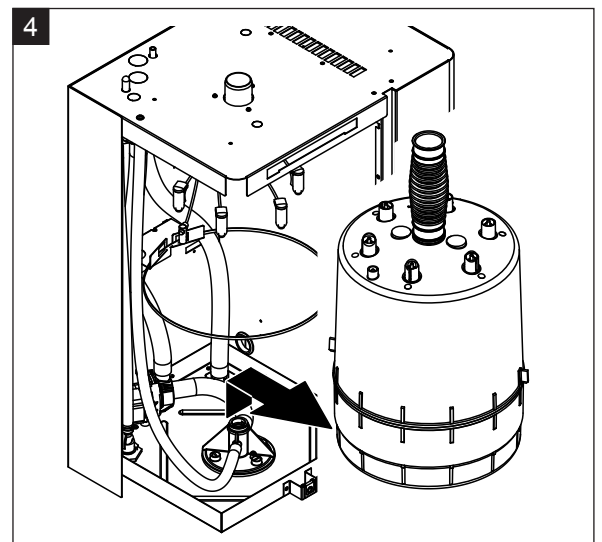
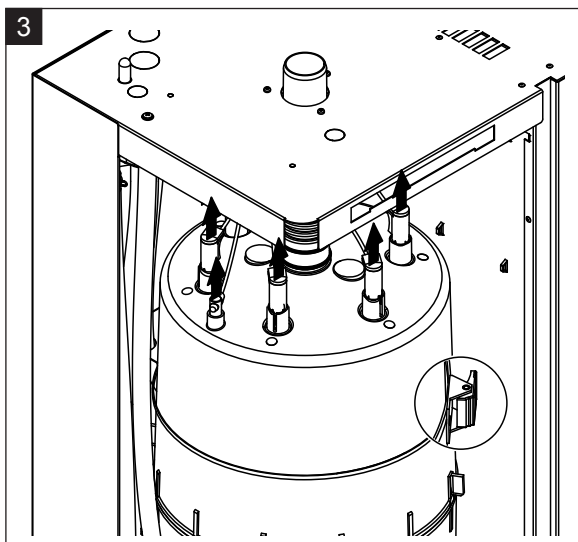

3. Remove all plugs from the electrodes and from the level sensor. Then, press the tab of the cable tie holding the cylinder in place and pull the cable tie open.
4. Carefully lift the steam cylinder out of steam cylinder receptacle and remove it towards the front of the unit.

! CAUTION!

Put steam cylinder down carefully to avoid damage to the lower connection piece!

Installation of the steam cylinder

Assembly of the steam cylinder takes place in reverse sequence of the removal. Please note the following instructions:

- For safety reasons the O-ring in the cylinder receptacle must be replaced by a new one. Before installing the steam cylinder, moisten the O-ring with water (**do not use grease or oil**).
- Make sure the new cylinder is the same model as the one that was removed. Model number is on top left corner of cylinder label.
- Attach rubber sleeve to the steam outlet of the steam cylinder and fasten rubber sleeve with hose clamp.

! CAUTION!

The outlet connector of the steam cylinder is made of plastic. **Do not overtighten** the hose clamp on the steam connector of the steam cylinder.

A leaky steam hose can cause damage due to moisture inside the unit.

- Carefully insert the steam cylinder into the receptacle and push the steam cylinder down to the stop. Then, attach rubber sleeve to the steam outlet connector in the unit cover and fasten rubber sleeve with hose clamps.

! CAUTION!

The steam outlet connector is made of plastic. **Do not overtighten** the hose clamp on the steam outlet connector.

A leaky steam hose can cause damage due to moisture inside the unit.

- Attach colour coded cylinder plugs to the corresponding colour coded electrode pin and push down completely. Connect plug of the sensor cable to the connector pin of high water sensor and push down completely.

	Steam cylinder type	
	A363 / D363 A464 / D464	A664 / D664 A674 / D674
Cable configuration		

6.3.2 Disassembly and assembly of the cleanable steam cylinder type D...

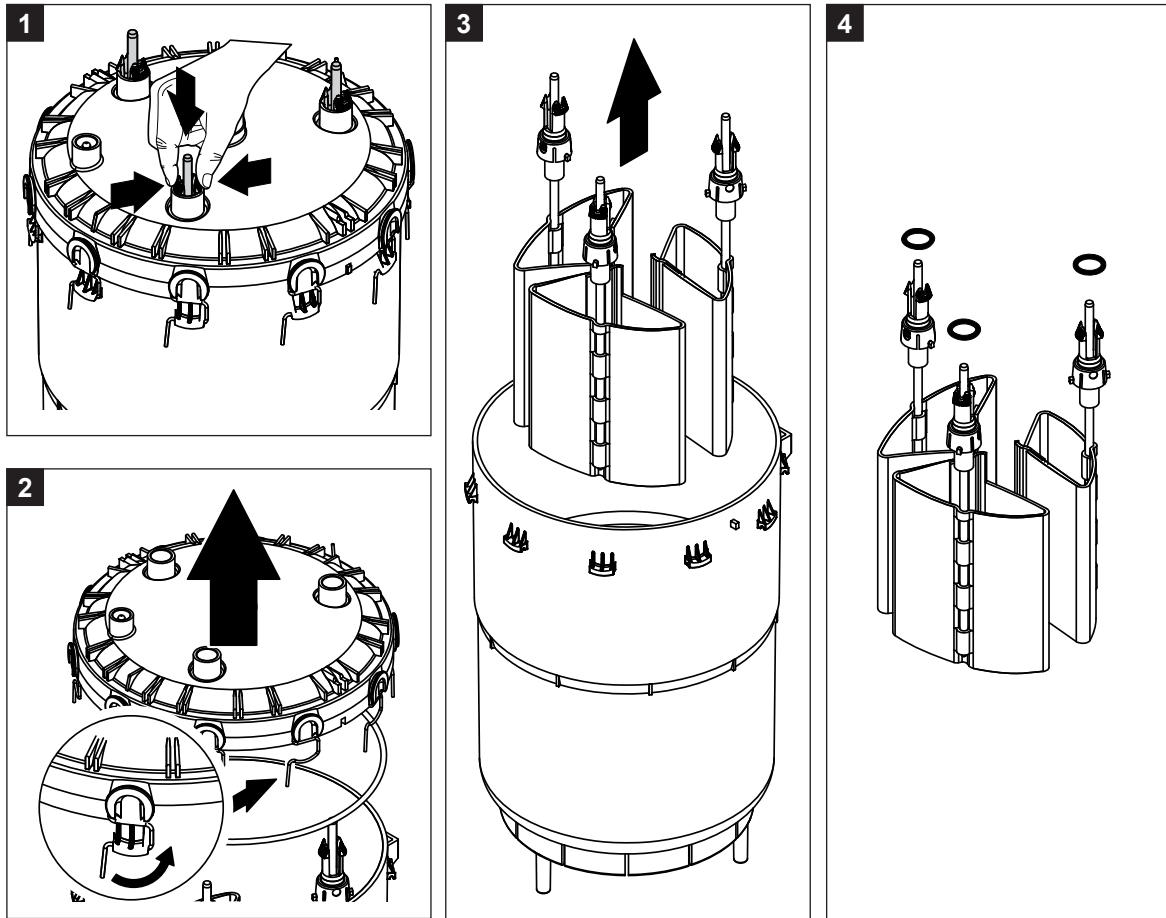

1. Pinch electrode snap fastenings and push electrodes approx. 2 cm downwards into the steam cylinder.
2. Release clamp clips of the cylinder cover and raise cover.
3. Remove carefully electrodes by lifting upwards.
4. Remove O-rings from the electrodes.
Note: Intact O-rings can be reused.

The **assembly** of the cleanable steam cylinder follows the reverse sequence of the removal. **Observe the following:**

- Before assembling the steam cylinder, check the O-ring in the steam cylinder cover and the O-rings on the electrodes for damage, and replace if necessary. Make sure to relocate O-rings correctly.
- Insert electrodes into steam cylinder cover and push them upwards until the snap fasteners engage.
- Place the cylinder cover (with mounted O-ring) in the correct position (align the two cams on the steam cylinder body with the corresponding grooves in the cylinder cover) on the cylinder body and secure cover with the fastening clips.

6.3.3 Removal and installation of the fill cup and the water hoses

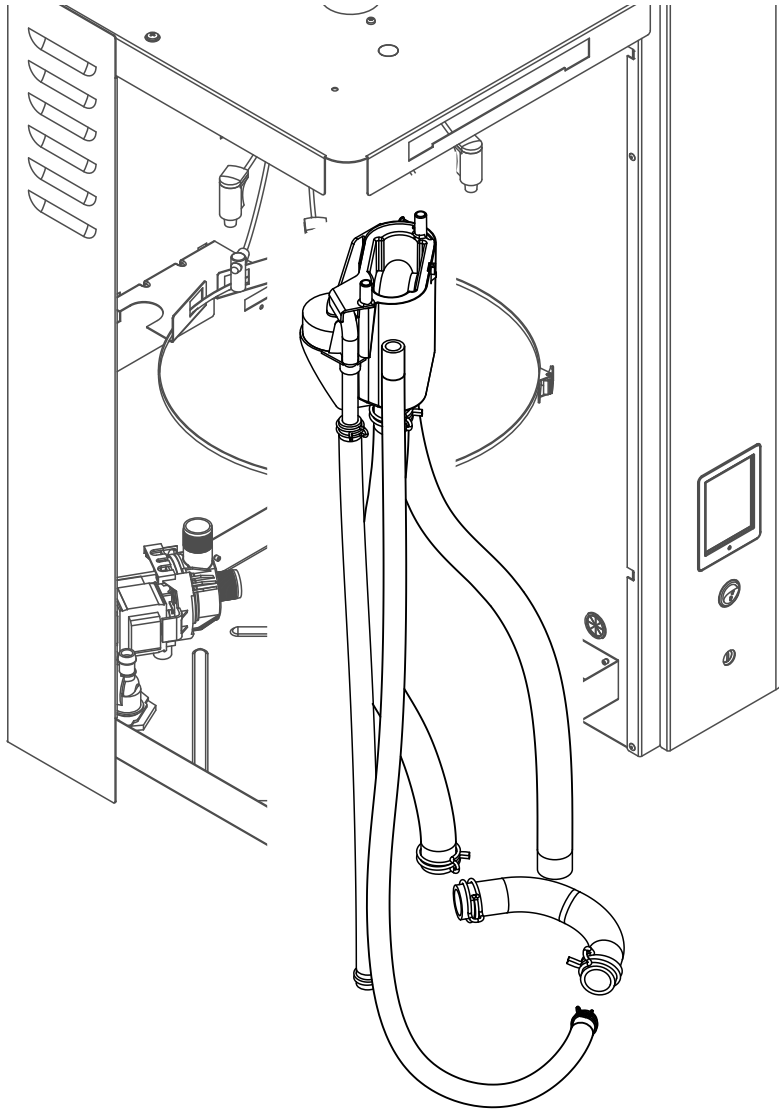

For removing the fill cup and the water hoses the steam cylinder must be removed first (see [chapter 6.3.1](#)).

1. Release hose clamps using pliers, then disconnect all hoses from the corresponding connectors and remove the hoses.
Note: The hoses connected to the fill cup may also be removed together with the fill cup (see figure above) and then disconnected from the connectors of the fill cup outside the unit.
2. **Carefully** pull fixing clip of the fill cup to the front, then push fill cup down from the holding device and remove it to the front.

The **installation** of the fill cup and the water hoses follows the reverse sequence of the removal. Before fixing the water hoses to the connector with the hose clamps, align the hoses in a way that they are not twisted.

6.3.4 Removal and installation of the drain pump

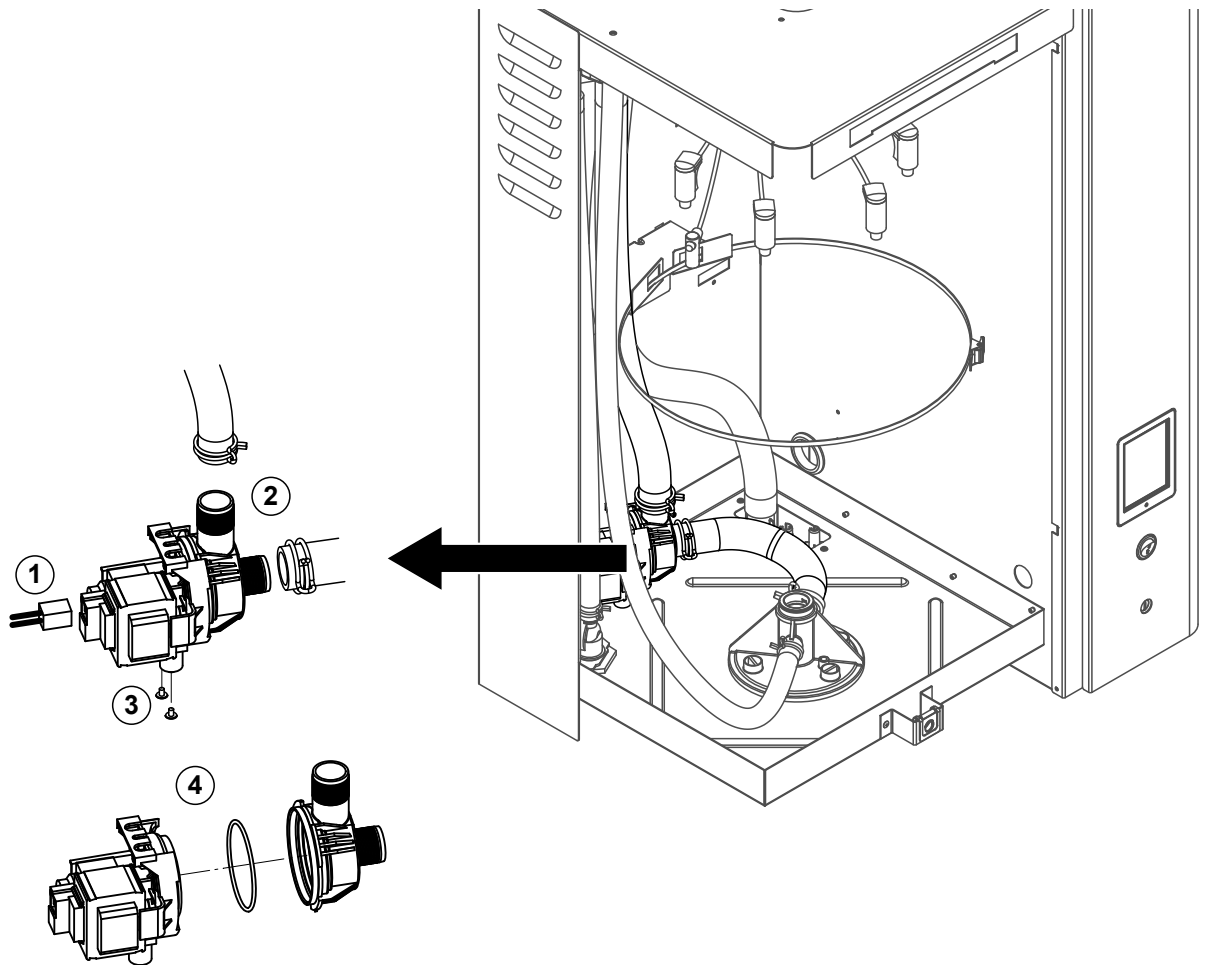

For removing the drain pump the steam cylinder must be removed first (see [chapter 6.3.1](#)).

1. Detach electric cables (polarity of the cables need not be observed).
2. Release hose clamps and remove the hoses from the connectors.
3. Undo the two screws on the bottom of the housing with Phillips screwdriver, then remove drain pump.
4. Separate the pump body from the pump drive: release the lock on the bayonet catch, then counter-rotate the pump body and the pump drive. Remove O-ring.

The **assembly** and the **installation** of the drain pump follows the reverse sequence of the removal. Before assembling the pump, check O-ring for damage and replace if necessary. Then, place the O-ring on the centering collar and moisten the O-ring with water.

6.3.5 Removal and installation of the inlet valve

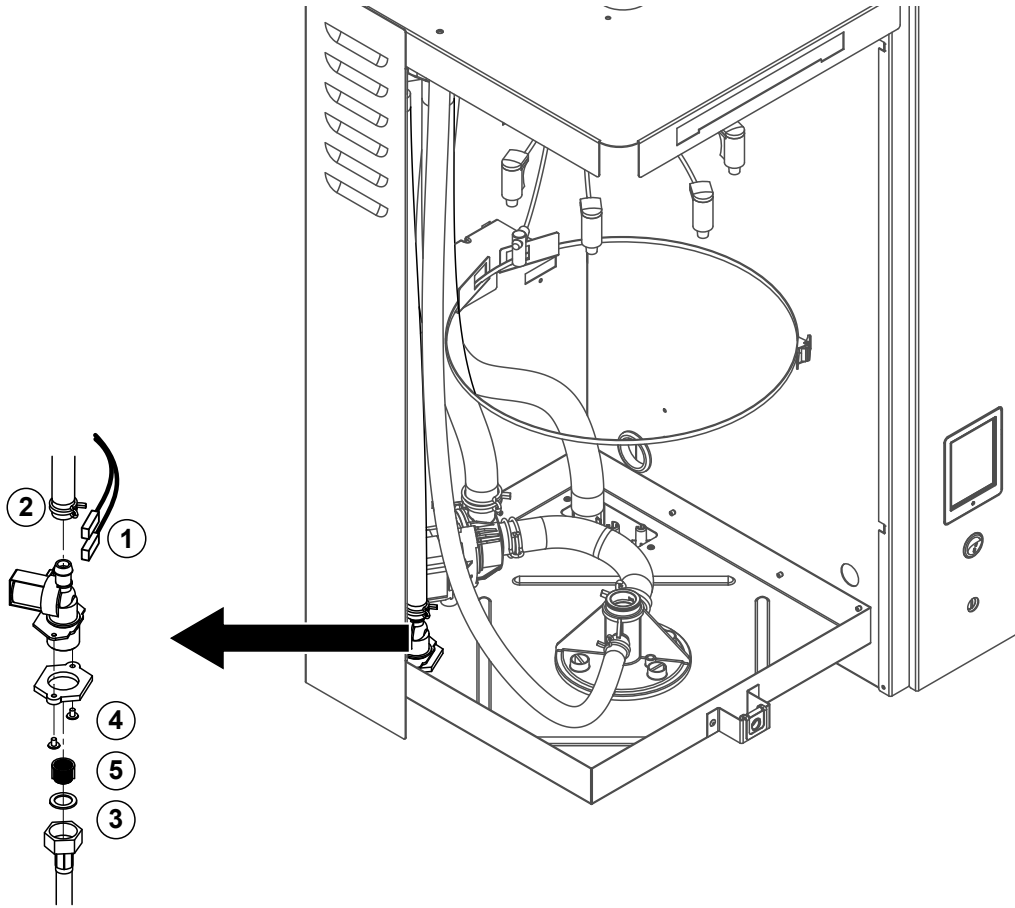

For removing the inlet valve the steam cylinder must be removed (see [chapter 6.3.1](#)).

1. Detach electric cables (polarity of the cables need not be observed).
Important: on multiple valves (units with option drain cooling) ensure to reconnect the connecting cables to same valve (note position).
2. Release hose clamp(s) and remove the hose(s) from the connector(s).
3. Undo water supply pipe and remove.
4. Undo the two screws on the bottom of the housing with Phillips screwdriver, then remove inlet valve.
5. Remove strainer insert with pointed pliers.

The **installation** of the inlet valve follows the reverse sequence of the removal. Before installing the valve make sure the strainer insert is installed in the inlet valve

6.3.6 Removal and installation of the steam cylinder receptacle

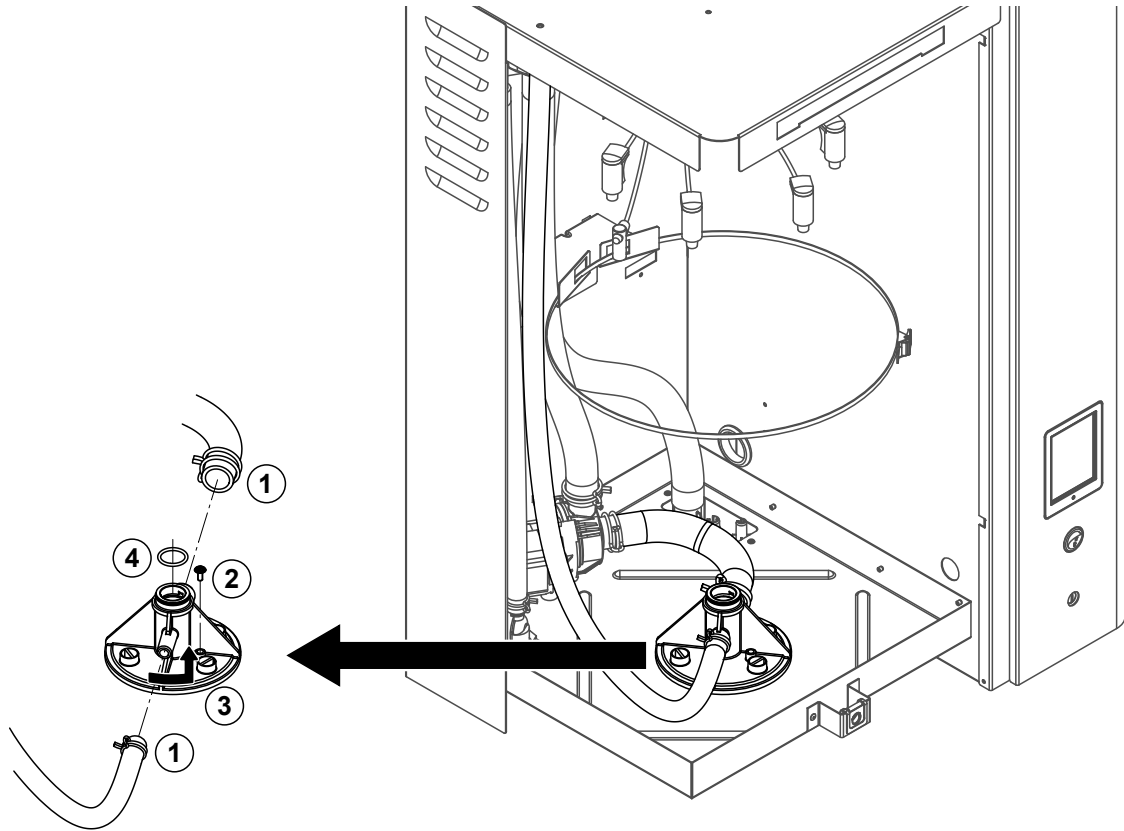

For removing the steam cylinder receptacle the steam cylinder must be removed first (see [chapter 6.3.1](#)).

1. Release hose clamps and remove hoses from the connectors.
2. Undo the screw fixing the cylinder receptacle to the bottom of the housing with Phillips screwdriver.
3. Turn cylinder receptacle counterclockwise to the stop and remove cylinder receptacle upwards.
4. Remove O-ring.

The **installation** of the steam cylinder receptacle follows the reverse sequence of the removal. For safety reasons the O-ring in the steam cylinder receptacle must mandatory be replaced.

6.3.7 Removal and installation of the drain cup

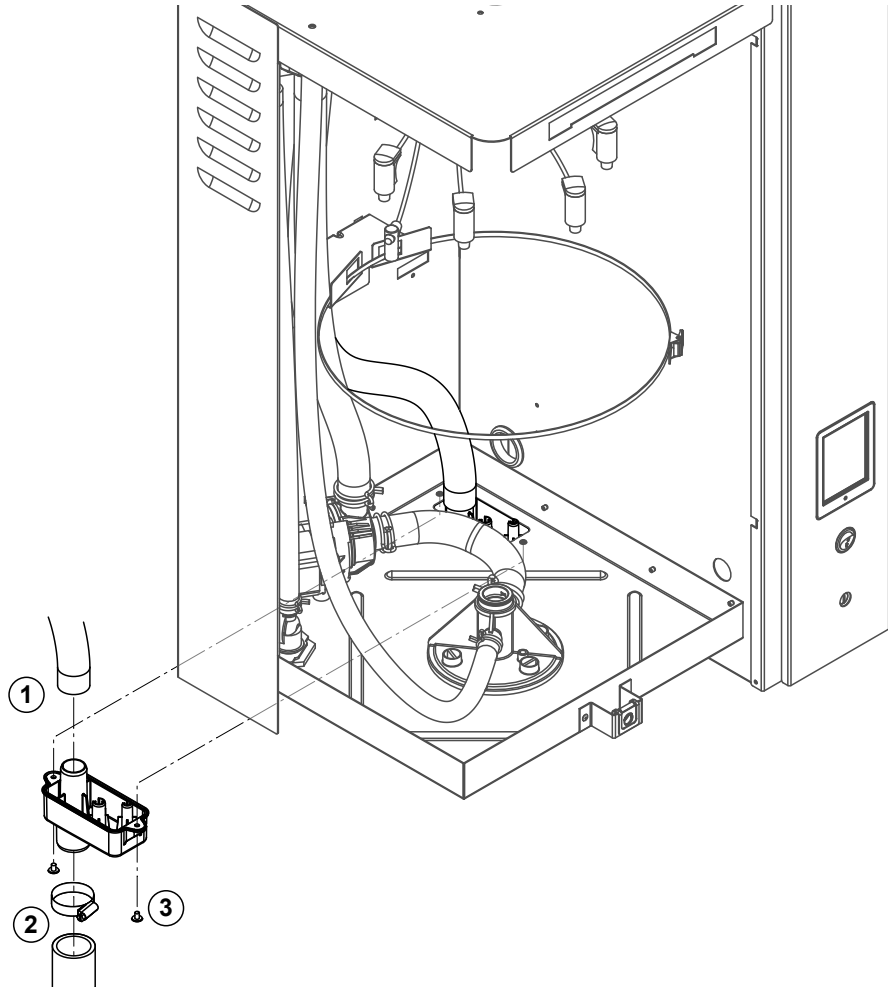

For removing the drain cup the steam cylinder must be removed first (see [chapter 6.3.1](#)).

1. Remove hose from the connector.
2. Release hose clamp of the external drain hose and remove hose.
3. Undo the two screws fixing the drain cup to the bottom side of the housing with Phillips screwdriver. Then, remove drain cup downwards.

The **installation** of the steam drain cup follows the reverse sequence of the removal. For safety reasons make sure the hoses are correctly attached to the drain cup and secured with the hose clamps.

6.4 Notes on cleaning the unit components

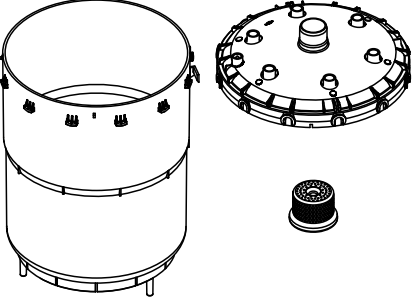
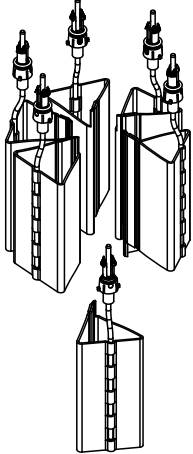
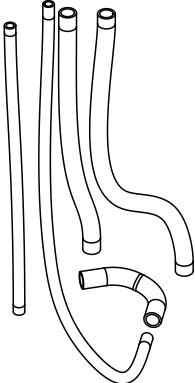
Unit component	What to clean and how to clean
<p>Cleanable steam cylinder only: Steam cylinder cover Steam cylinder body Cylinder strainer</p> 	<ul style="list-style-type: none"> • Knock off or brush away any limescale as much as possible (do not use a wire brush). If the parts are heavily calcified, place them in an 8% formic acid solution (observe safety notes in chapter 6.5), until the limescale comes off. • Rinse well with hot tap water.
<p>Heating electrodes</p> 	<ul style="list-style-type: none"> • Immerse the heating electrodes (up to 2 cm below the snap fastening) in a container with 8-percent formic acid (observe safety notes in chapter 6.5). Allow the acid to take effect until the limescale has dissolved. Note: The heating elements do not have to be entirely free from scale. • Rinse the heating electrodes well with hot tap water and let them dry. <p>CAUTION: On no account remove limescale from the heating electrodes using tools (screwdriver, scraper, etc.) or by striking. This could damage the heating elements.</p>
<p>Water hoses</p> 	<ul style="list-style-type: none"> • Remove any limescale by slightly knocking on the tubes using a rubber hammer. Then, rinse the tubes well with hot tap water.

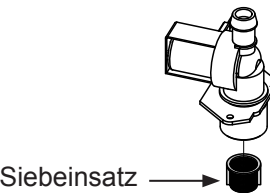
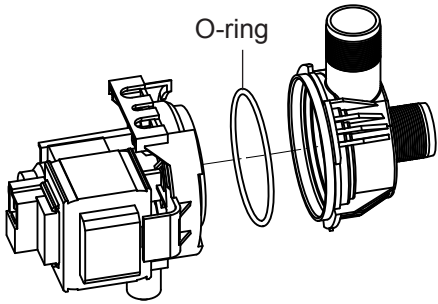
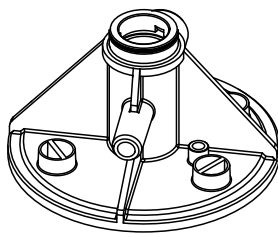
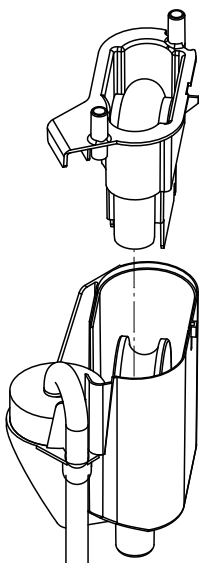
Unit component	What to clean and how to clean
<p data-bbox="247 212 383 241">Inlet valve</p> 	<ul data-bbox="742 212 1428 403" style="list-style-type: none"> • Use a soft bristled brush (do not use a wire brush) to remove any limescale inside the inlet valve and on the strainer. • Rinse inlet valve and strainer insert with hot tap water. Let the inlet valve dry before reinstallation!
<p data-bbox="247 504 399 533">Drain pump</p> 	<ul data-bbox="742 504 1428 728" style="list-style-type: none"> • Use a soft bristled brush (do not use a wire brush) to remove any limescale from the pump housing and the pump wheel. • Wipe pump wheel with a damp cloth. Rinse pump housing with hot tap water. Let the drain pump dry before reinstallation!
<p data-bbox="247 896 502 925">Cylinder receptacle</p> 	<ul data-bbox="742 896 1428 1142" style="list-style-type: none"> • Remove any limescale from the cylinder receptacle and its connectors using a soft bristled brush (do not use a wire brush). If the cylinder receptacle is heavily calcified, place it in an 8% formic acid solution (safety notes in chapter 6.5), until the limescale comes off. • Rinse the cylinder receptacle with hot tap water.
<p data-bbox="247 1220 343 1249">Fill cup</p> 	<ul data-bbox="742 1220 1428 1534" style="list-style-type: none"> • Disassemble fill cup. • Remove any limescale from the fill cup and its connectors using a soft bristled brush (do not use a wire brush). If fill cup is heavily calcified, place it in an 8% formic acid solution (observe safety notes in chapter 6.5), until the limescale comes off. • Rinse components of the fill cup with hot tap water. • Reassemble fill cup.

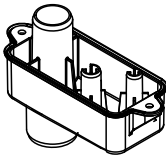
Unit component	What to clean and how to clean
<p data-bbox="284 212 411 241">Drain cup</p> 	<ul style="list-style-type: none"> <li data-bbox="783 212 1471 309">• Use a soft bristled brush (do not use a wire brush) to remove any limescale from the drain cup and its connectors. <li data-bbox="783 315 1471 412">If the drain cup is heavily calcified, place it in an 8% formic acid solution (observe safety notes in chapter 6.5), until the limescale comes off. <li data-bbox="783 427 1283 456">• Rinse the drain cup with hot tap water.
<p data-bbox="284 481 520 546">Interior of the unit (water side only)</p>	<p data-bbox="783 481 1471 546">Wipe the interior of the unit with a damp cloth without using any cleaning agent.</p> <p data-bbox="783 562 1471 624">CAUTION! Take care that the electrical connections and the electronic components remain dry.</p>

6.5 Notes on cleaning agents

Only use cleaning agents stated in the table above. The use of disinfectants is only permitted if they do not leave any toxic residues. In any case the parts must be thoroughly rinsed with hot tap water after cleaning.

Do not use soap to clean the parts since residual soap can cause foaming which will affect proper operation of the humidifier.



WARNING!

Formic acid is indeed harmless to the skin, but it attacks the mucous membranes. Therefore prevent your eyes and respiratory tracts from getting in touch with the acid and its vapours (wear goggles and work in a well ventilated room or outside).



CAUTION!

Do not use any solvents, aromatized or halogenized hydrocarbons or other aggressive substances as they may cause damage to the components of the unit.

It is mandatory to observe and comply with the information and instructions regarding cleaning agents. Observe in particular: all information relating to the protection of personnel, environmental protection and restrictions regarding usage.

6.6 Resetting the cylinder status



CAUTION!

DO NOT reset the cylinder status in the control software unless the steam cylinder has been replaced/cleaned.

After the steam cylinder has been replaced/cleaned the cylinder status (for module A or module B or for both) must be reset. Proceed as follows:

Note: On double units and large units with two steam cylinders, individually reset the appropriate cylinder monitoring function.

1. Select in the "Service" submenu the corresponding cylinder reset function.

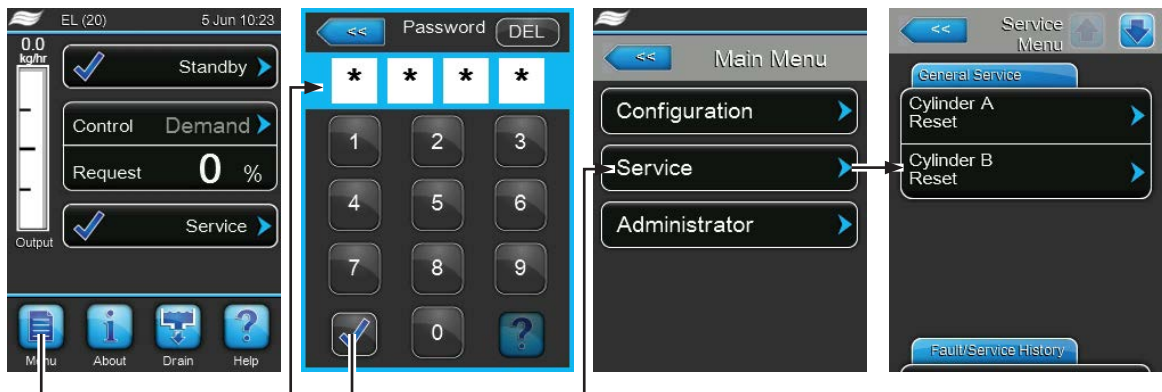

Password: 8808

2. The reset dialogue appears:

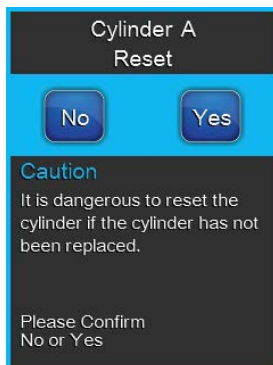

- Press the **<Yes>** button to reset the selected cylinder. The "Cylinder Spent" message and cylinder status is reset.
- Press the **<No>** button if the maintenance work has not been completed and you want abort the reset procedure. The control unit returns to the "Service" submenu.

6.7 Performing software and firmware updates



DANGER!
Danger of electric hazard!

The Condair EL is mains powered. Live parts may be exposed when the door panels of the steam humidifier are removed. Touching live parts may cause severe injury or danger to life.

Prevention: Before carrying out any work on the Condair EL switch off the unit, disconnect it from the mains and secure the unit against inadvertent power-up.

To update the control software or the driver board firmware, proceed as follows:

1. Set the On/Off switch on the front side of the steam humidifier to the Off position, then switch off the voltage supply to the steam humidifier via the external disconnect switch (electrical isolator) and secure switch in the off position to prevent it from inadvertent power up.
2. Unlock the door panel on the control compartment side of the steam humidifier and remove it.
3. Swing control panel assembly open.
4. Carefully insert FAT32 formatted USB memory stick containing the software updates into the USB port on the control board. Make sure that the maximum length of the memory stick does not exceed 75 mm.

Note: in order to update the control software or the firmware of the driver board a USB stick with a valid software update (the update files must be on the highest level outside of any folder) must be connected to the USB port on the control board. Otherwise, an appropriate fault message appears when starting the software update.

5. Close control panel assembly, then close the door panel of the control compartment and lock it with the screw.
6. Remove the lock and tag from the external disconnect switch. Then, switch on external disconnect switch to restore power to the humidifier.
7. Set the On/Off switch on the front side of the steam humidifier to the On position.
8. When the standard operating display appears, select the **<Menu>** button, then enter the password (8808) to login.
9. Select "Administrator > Software Update tab", then select the desired update function:
 - select "**Software Update**" to update the control software,
 - select "**Driver Board A.DB.A**" update the firmware for the driver board of Module A
 - select "**Driver Board A.DB.B**" update the firmware for the driver board of Module B (on double unit or large units with two steam cylinders),

The update starts. A progress bar is shown in the display. If the update has completed the control unit returns to the standard operating display.



CAUTION!

Do not interrupt a software or firmware update once it has started. Wait until updating is completed. Corrupted control software or firmware can render the humidifier unusable.

Note: If software update is accidentally interrupted, the humidifier will not operate, but the software update can be resumed by leaving the USB key inserted in the control board and power cycling the unit. The integrated controller will detect the software was not properly installed, and restart the update.

10. Repeat steps 1 to 3, then carefully remove the USB memory stick.
11. Close control panel assembly, then close the door panel of the control compartment and lock it with the screw.
12. Repeat Step 6 and 7 to power up the humidifier.

7 Fault elimination

7.1 Fault indication

Malfunctions during operation detected by the control software are indicated by a corresponding **Warning** message (operation still possible) or **Fault** message (operation not longer possible) in the maintenance and fault indication field in the standard operating display of the control unit.

Warning



Temporary problems (e.g. water supply interrupted for a short time) or malfunctions which cannot cause damage to the system are indicated with a warning message. **If the cause of the malfunction disappears of its own accord within a certain period of time, the alarm message will automatically be reset, otherwise a fault message is triggered.**

Note: warnings can be indicated also via the service relay of the remote operating and fault indication. The warning indication via the service relay must be activated in the communication menu of the control software (see [chapter 5.4.5](#)).

Fault



Operational states where further operation is not possible, or where further operation would damage the system are indicated with a fault message, additionally the red fault indicator LED below the touch panel will lights up. If such a malfunction occurs, the steam production of the Condair EL will be **stopped automatically**.

By pressing on the maintenance and malfunction indication field in the standard operating display, the error list will show all active warning and fault messages. By pressing on the corresponding Warning or Fault entry, additional information regarding the malfunction is displayed (see display on the far-right).

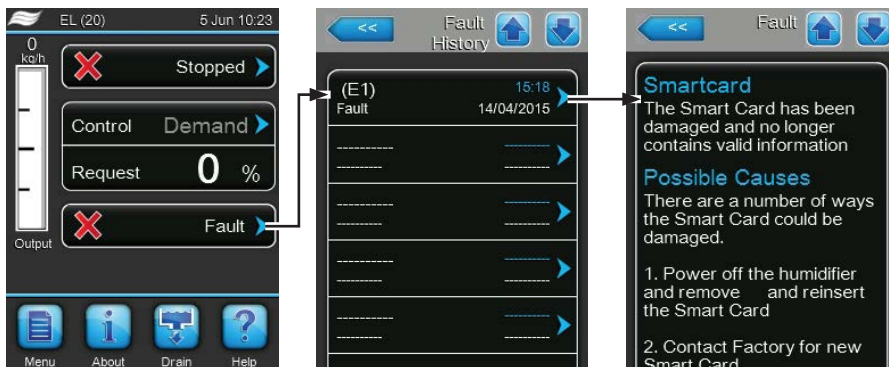

7.2 Malfunction list

Most operational malfunctions are not caused by faulty equipment, but rather by improper installation or disregarding of planning guidelines. Therefore, a complete fault diagnosis always involves a thorough examination of the entire system (e.g. hose connections, humidity control system, etc.).

Code		Message	Information	
Warning	Fault		Possible causes	Remedy
W01	E01	Smart Card	No communication with SIM card.	
			No SIM card installed.	Contact your Condair representative
			SIM card defective.	Contact your Condair representative.
W06	—	Main missing (displayed on extension unit) or Ext missing (displayed on main unit)	No communication between main unit and extension unit.	
			Bus cable between main unit and extension unit not connected or interrupted.	Check/connect bus cable.
			Main or extension unit not switched on.	Switch on main unit and/or extension unit.
W07	—	Ext Fault	No communication between Linkup units. Note: this message is shown only on Main units.	
			Extension unit(s) in fault condition.	Check extensions unit(s).
W12	—	On/Off Timer	The humidifier is turned off by the On/Off timer.	
			The On/Off timer is active and has turned off the humidifier.	No action is required..
W20	E20	Safety Loop	External safety chain is open, humidification is stopped! Note: as soon as the safety chain is closed again the Condair EL continues to work normally.	
			Ventilation interlock open.	Check/switch on fan of the AHU.
			Air proving switch has triggered.	Check fan/filter of the AHU.
			High limit humidistat has triggered.	Wait, check/replace high limit humidistat.
			Fuse "F3" on the driver board defective.	Replace fuse "F3" on the driver board.
—	E21	Max. Level	Max. filling level of steam cylinder reached but no current.	
			Water conductivity too low (after initial operation).	Wait until the mineral content of the cylinder has increased
			Water conductivity too low for type of steam cylinder selected in the software.	Select correct steam cylinder type.
			Phase failure heating voltage.	Check service switch in the mains supply line and switch on if applicable. Check mains fuse(s) and replace if applicable.
W21	—	No Current	Water level is at the top of the cylinder, or foaming was detected.	
			Humidifier has filled to the top of the cylinder without reaching demand.	No action is required. For information purposes only: It is normal for a new cylinder to reach the maximum level before water in the cylinder is concentrated, and for an old cylinder to reach maximum level near the end of its life cycle. If the cylinder is new, add 1/4 tea spoon (1.25 ml) of salt to the fill cup to raise the conductivity level.
			The conductivity of the water supply may be too low.	Use potable water supply with conductivity greater than 150 µS/cm.

Code		Message	Information	
Warning	Fault		Possible causes	Remedy
W22	E22	Fill Timeout	Permissible filling time exceeded.	
			Water feed blocked, shut-off valve in the water supply line closed, filter valve closed or blocked). Water pressure too low.	Check water feed (filter, pipes, etc.), check/open shut-off valve, Check water pressure.
			Inlet valve blocked or defective.	Check strainer inside the inlet valve, clean if necessary. Replace valve.
			Excessive back pressure in the steam line (duct pressure too high, steam line too long or kinked), causing water loss via fill cup.	Check duct pressure, inspect steam installation. If applicable install pressure compensation kit (available as option).
			Water system leaky.	Check/seal water system.
W23	E23	Current Timeout	No electrode current	
			Phase failure heating voltage.	Inspect/turn on service switch of the mains supply line. Inspect the fuses of the mains supply, replace if necessary. Check/replace main contactor.
			Water supply obstructed/shut-off valve closed/water pressure too low.	Inspect water supply (filter, water piping, etc.), check/open shut-off valve, check water pressure.
			Inlet valve blocked or defective.	Inspect strainer insert of the inlet valve, if applicable clean strainer insert or replace inlet valve.
			Excessive back pressure in the steam line (duct pressure too high, steam line too long or kinked), causing water loss via fill cup.	Check duct pressure, inspect steam installation. If applicable install pressure compensation kit (see options).
Leakage in the water system.	Inspect water system and seal if necessary.			
W24	E24	Overcurrent	Electrode current in relation to the steam demand too high	
			Humidity demand has decreased too fast.	Automatic adaptation of the operating point.
			Drain pump defective.	Inspect drain pump, replace if necessary.
			Drain in steam cylinder blocked.	Replace/clean steam cylinder.
			Water conductivity too high for the selected steam cylinder type.	Select correct steam cylinder type.
W25	E25	Excess Current	Max. admissible electrode current exceeded	
			Drain pump defective.	Inspect drain pump, replace if necessary.
			Drain in steam cylinder blocked.	Replace/clean cylinder.
			Water conductivity too high for the selected steam cylinder type.	Select correct steam cylinder type.
—	E26	Current Off	Current detected without humidity demand.	
			Main contactor stucked in closed position.	Check/replace main contactor.
			EMI source nearby the humidifier.	Eliminate EMI source.
			Driver board out of calibration.	Replace driver board.
W27	E27	Foam	Foam detected in the steam cylinder.	
			Foaming in steam cylinder.	Drain steam cylinder (several times, if necessary). Check quality of the supply water.

Code		Message	Information	
Warning	Fault		Possible causes	Remedy
W28	—	Cylinder spent	Steam cylinder maintenance due	Steam cylinder Type A: replace Steam cylinder Type D: clean (max. 4 times) Important: After replacement or cleaning of the steam cylinder, reset the cylinder status (see chapter 6.6).
			Electrodes spent.	
—	E29	Cylinder spent	Electrodes in steam cylinder spent. Condair EL has stopped operation.	Steam cylinder Type A: replace Steam cylinder Type D: clean (max. 4 times) Important: After replacement or cleaning of the steam cylinder, reset the cylinder status (see chapter 6.6).
			Electrodes spent, maximum operating hours of the steam cylinder reached.	
W32	—	CTRL Signal (or) RH Signal	Humidity signal invalid, Condair EL has stopped operation!	Check/correctly connect humidity sensor/humidistat. Check/correct the Signal Type setting for the sensor/humidistat in the control software Replace sensor/humidistat.
			Humidity sensor/humidistat not or not correctly connected.	
			Signal type for the sensor/humidistat signal incorrectly configured (e.g. mA instead of V signal) in control software	
			Sensor/humidistat defective.	
W34	—	Rem disable	The humidifier is disabled remotely by the BMS (building management system) or by remote enable switch (connected to X11 terminal on the driver board) being opened. See "Remote Disable" on page 40 .	Activate the humidifier via BMS or switching on the remote enable switch (as applicable).
			The humidifier is disabled remotely by the BMS or by remote enable switch.	
W35	—	BMS T/O (timeout)	The maximum wait time without any communications from the BMS has been exceeded. If the signal Source is set to "Analog", the humidifier will continue operating; otherwise it stops producing steam until communications with the BMS is re-established.	
W39	—	Unstable signal	Control signal unstable.	Check humidity control system. Correctly place humidity sensor. Correctly adjust proportional and/or integral value on P/PI controller.
			Layout of humidity control system wrong.	
			Humidity sensor not placed correctly.	
			Proportional and/or integral value on P/PI controller not set correctly.	
W42	—	RH High	Humidity value has exceeded the set high limit humidity value.	Check humidity control system. Correctly adjust proportional and/or integral value on P/PI controller. Run humidifier with capacity limitation. Adjust RH high limit value.
			Layout of the humidity control system wrong or components defective.	
			Humidifier capacity too large.	
			RH high limit set too low.	
W43	—	RH Low	Humidity value has undershooting the set low limit humidity value.	Check humidity control system. Adjust RH low limit value.
			Layout of the humidity control system wrong or components defective.	
			RH low limit set too high.	
—	E57	Activation	Activation code has not been entered yet.	Enter activation code (code available from your Condair representative).
			Activation code has not been entered yet.	

Code		Message	Information	
Warning	Fault		Possible causes	Remedy
W71	—	Low conductivity	If the cylinder has had reduced operating capacity and excessive high water sensor activations before the break-in period of the cylinder has expired the system will generate a low conductivity warning instead of a spent cylinder notification. This will allow decrementation of the high water sensor counter for a period of operating time before generating a spent cylinder code.	
			Wrong cylinder type installed	Install steam cylinder for low conductivity.
			Cylinder receptacle leaking.	Check/seal/replace cylinder receptacle.
			Supply water has too low water conductivity.	Connect water supply with water conductivity in admissible range.
—	E84	Driver fault	No communication between the controller and the driver board	
			Driver board defective.	Let have the driver board be replaced by an electrician.
			Driver board ID wrong.	Check rotary switch SW1 on the driver board and set correctly (0 for cylinder A, 1 for cylinder B).
			Communication cable between the driver board and the control board not connected properly	Make sure the RS485 cable is connected to RS4851 on the driver board and J12 on the control board.
W125	—	Capacity Timer	The capacity limitation is currently controlled via Capacity Timer function.	
			The Capacity Timer is active and has over ridden the normal operation.	No action is required.
W126	—	Setpoint Timer	The setpoint is currently controlled via the Setpoint Timer function.	
			The Setpoint Timer is active and has over ridden the normal operation.	No action is required.
—	E128	Current Sensor	Current sensor not able to be calibrated on system start-up.	
			Current sensor not able to be calibrated on system start-up	Contact your Condair representative.
—	E130	Current Circuit	Current monitoring circuit has detected that current has exceeded maximum allowable current.	
			Current coils disconnected or not functioning.	Check wiring between current coils and driver board.
			One of the phases is disconnected.	Check fuses, wiring to humidifier, and supply voltage is present on all phases.
			Electrode plugs on cylinder not connected.	Check that all Electrode plugs are properly connected and that wiring is secure to contactor.
			Inlet valve stuck open.	Check that the inlet valve is closed, after full output is reached. If not, check/Replace inlet valve if necessary.
			Drain pump is blocked preventing drain to dilute cylinder water.	Check that water drains correctly from cylinder when manual drain is activated. If not, check/Replace drain pump if necessary.
—	E131	Missing Coil	One of the current coils used for monitoring the humidifiers current is not detected.	
			Current coil is not connected.	Check/connect wires between current coils and driver board.

7.3 Saving fault and service histories to a USB memory stick

The fault and service histories of the Condair EL can be saved to a USB memory stick for logging and further analysis. For this purpose proceed as follows:



DANGER!
Danger of electric hazard!

The Condair EL is mains powered. Live parts may be exposed when the door panels of the steam humidifier are removed. Touching live parts may cause severe injury or danger to life.

Prevention: Before carrying out any work on the Condair EL switch off the unit, disconnect it from the mains and secure the unit against inadvertent power-up.

1. Set the On/Off switch on the front side of the steam humidifier to the Off position, then switch off the voltage supply to the steam humidifier via the external disconnect switch (electrical isolator) and secure switch in the off position to prevent it from inadvertent power up.
2. Unlock the door panel on the control compartment side of the steam humidifier and remove it.
3. Swing control panel assembly open.
4. Carefully insert FAT32 formatted USB memory stick into the USB port on the control board. Make sure that the maximum length of the memory stick does not exceed 75 mm.
5. Close control panel assembly, then close the door panel of the control compartment and lock it with the screw.
7. Remove the lock and tag from the external disconnect switch. Then, switch on external disconnect switch to restore power to the humidifier.
7. Set the On/Off switch on the front side of the steam humidifier to the On position.
8. When the standard operating display appears, select the **<Menu>** button, then enter the password (8808) to login.
9. Select "**Service > Fault/Service History tab > Export History**". The last 40 humidifier fault and service history events are then downloaded to the memory stick as separate .csv files labelled "WARNING_FAULT.csv" and "SERVICE_HISTORY.csv".
Note: the CSV tables can be processed with a spread-sheet program on a PC
10. Repeat steps 1 to 3, then carefully remove the USB memory stick.
11. Close control panel assembly, then close the door panel of the control compartment and lock it with the screw.
12. Repeat Step 6 and 7 to power up the humidifier.

7.4 Notes on fault elimination

- For the elimination of faults set the Condair EL out of operation (see [chapter 4.5](#)) and disconnect it from the mains.



DANGER!
Danger of electric hazard!

Make sure the Condair EL is separated from the mains (check with voltage detector) and the shut-off valve in the water supply line is closed.

- The elimination of faults must be carried out by qualified and well trained professionals only. Malfunctions relating to the electrical installation must be repaired only by an authorized electrician or the Condair service technician.



CAUTION!

Electronic components are very sensitive to electrostatic discharge. When carrying out repairs to the Condair EL, appropriate measures (ESD-protection) must be taken to prevent damage to electronic components.

7.5 Resetting the fault indication

To reset the error indication (red LED lights and the maintenance and -malfunction indication field shows "Fault"):

1. Switch off the Condair EL via the unit switch.
2. Wait approx. 5 seconds, then switch on the Condair EL again.

Note: If the fault has not been eliminated, the fault indication reappears after a short while.

7.6 Replacing the fuses and backup battery in the control compartment

The fuses of the control unit must be replaced by **authorized personnel only** (e.g. electrician).

Replace fuses of the control unit only with fuses matching the specifications below with the appropriate nominal current capacity .

Never use refurbished fuses. Do not bridge the fuse holder.

To replace the fuses or the backup battery proceed as follows:

1. Disconnect control unit from the mains by switching off the electrical isolator and secure electrical isolator in "Off" position against inadvertent switching on.
2. Undo the screw of the front cover of the control unit, then remove the front cover.
3. Swing control panel assembly open.
4. Replace desired fuse or the backup battery.



DANGER!

The contact protection of fuse "F3" must mandatory be relocated after the fuse has been replaced.

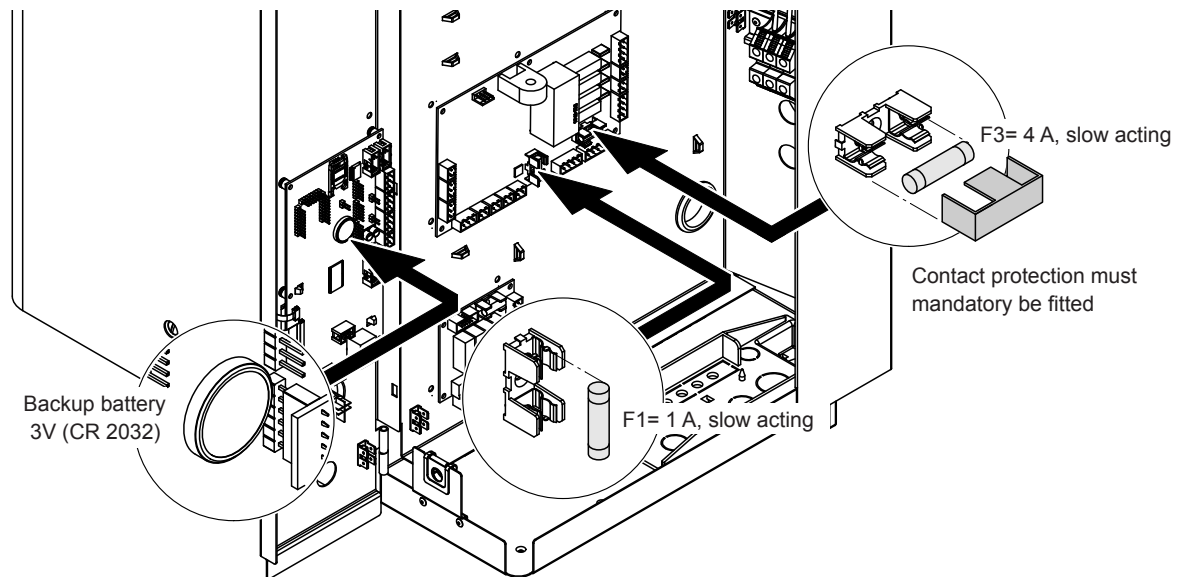

Fig. 6: Position of the backup battery and the fuses on the driver board

5. Close control panel assembly.
6. Relocate front cover on control unit and lock it with the retaining screw.
7. Reconnect Condair EL to the mains by switching on the electrical isolator.

8 Taking out of service/Disposal

8.1 Taking out of service

If the Condair EL must be replaced or if the Condair EL is not needed any more, proceed as follows:

1. Take the Condair EL out of operation as described in [chapter 4.5](#).
2. Have the Condair EL (and if applicable other system components) unmounted by a qualified service technician.

8.2 Disposal/Recycling

Components not used any more must not be disposed of in the domestic waste. Please dispose of the individual components in accordance with local regulations at the authorised collecting point.

If you have any questions, please contact the responsible authority or your local Condair representative.

Thank you for your contribution to environmental protection.

9 Product specification

9.1 Performance data

		Max. steam capacity in kg/h	Nominal power max. in kW	200 V/1~/50...60Hz			230 V/1~/50...60Hz			240 V/1~/50...60Hz			200 V/3~/50...60Hz			230 V/3~/50...60Hz			400 V/3~/50...60Hz		
	EL			Nominal current max. in A	Cable cross section A_L min. in mm ²	Heating voltage fuse "F5" in A	Nominal current max. in A	Cable cross section A_L min. in mm ²	Heating voltage fuse "F5" in A	Nominal current max. in A	Cable cross section A_L min. in mm ²	Heating voltage fuse "F5" in A	Nominal current max. in A	Cable cross section A_L min. in mm ²	Heating voltage fuse "F5" in A	Nominal current max. in A	Cable cross section A_L min. in mm ²	Heating voltage fuse "F5" in A	Nominal current max. in A	Cable cross section A_L min. in mm ²	Heating voltage fuse "F5" in A
S	EL 5	5	3.8	19.0	4.0	25	16.3	2.5	20	16.3	2.5	20	10.9	1.5	3x16	9.4	1.5	3x16	5.4	1.5	3x10
	EL 8	8	6.0	30.0	10.0	40	26.1	6.0	32	26.1	6.0	32	17.3	4.0	3x25	15.0	2.5	3x20	8.6	1.5	3x10
	EL 10	10	7.5	-	-	-	32.6	10.0	40	32.6	10.0	40	21.7	4.0	3x25	18.8	4.0	3x25	10.8	1.5	3x16
	EL 15	15	11.3	-	-	-	-	-	-	-	-	-	32.5	10.0	3x40	28.2	10.0	3x40	16.2	2.5	3x20
M	EL 20	20	15.0	-	-	-	-	-	-	-	-	-	43.3	16.0	3x63	37.7	16.0	3x63	21.7	4.0	3x25
	EL 24	24	18.0	-	-	-	-	-	-	-	-	-	52.0	16.0	3x63	45.2	16.0	3x63	26.0	6.0	3x32
	EL 30	30	22.5	-	-	-	-	-	-	-	-	-	65.0	25.0	3x80	56.5	25.0	3x80	32.5	10.0	3x40
	EL 35	35	26.3	-	-	-	-	-	-	-	-	-	-	-	-	-	-	-	37.9	16.0	3x63
	EL 40	40	30.0	-	-	-	-	-	-	-	-	-	-	-	-	-	-	-	43.3	16.0	3x63
	EL 45	45	33.8	-	-	-	-	-	-	-	-	-	-	-	-	-	-	-	48.7	16.0	3x63
2xM	EL 35	35	2x13.5	-	-	-	-	-	-	-	-	-	2x39.0	16.0	2x(3x63)	2x33.9	10.0	2x(3x40)	-	-	-
	EL 40	40	2x15.0	-	-	-	-	-	-	-	-	-	2x43.3	16.0	2x(3x63)	2x37.7	16.0	2x(3x63)	-	-	-
	EL 45	45	2x17.3	-	-	-	-	-	-	-	-	-	2x49.8	16.0	2x(3x63)	2x43.3	16.0	2x(3x63)	-	-	-
	EL 50	50	2x18.8	-	-	-	-	-	-	-	-	-	2x54.1	16.0	2x(3x63)	2x47.1	16.0	2x(3x63)	2x27.1	6.0	2x(3x32)
	EL 60	60	2x22.5	-	-	-	-	-	-	-	-	-	2x65.0	25.0	2x(3x80)	2x56.5	25.0	2x(3x80)	2x32.5	10.0	2x(3x40)
	EL 70	70	2x26.3	-	-	-	-	-	-	-	-	-	-	-	-	-	-	-	2x37.9	16.0	2x(3x63)
	EL 80	80	2x30.0	-	-	-	-	-	-	-	-	-	-	-	-	-	-	-	2x43.3	16.0	2x(3x63)
	EL 90	90	2x33.8	-	-	-	-	-	-	-	-	-	-	-	-	-	-	-	2x48.7	16.0	2x(3x63)
L	EL 50	50	37.5	-	-	-	-	-	-	-	-	-	-	-	-	-	-	-	54.1	16.0	3x63
	EL 60	60	45.0	-	-	-	-	-	-	-	-	-	-	-	-	-	-	-	65.0	25.0	3x80
	EL 70	70	52.5	-	-	-	-	-	-	-	-	-	-	-	-	-	-	-	75.8	35.0	3x100
	EL 80	80	60.0	-	-	-	-	-	-	-	-	-	-	-	-	-	-	-	86.6	35.0	3x100
	EL 90	90	67.5	-	-	-	-	-	-	-	-	-	-	-	-	-	-	-	97.4	50.0	3x125
3xM	EL 70	70	3x18.0	-	-	-	-	-	-	-	-	-	-	-	-	3x45.2	16.0	3x(3x63)	-	-	-
	EL 80	80	3x20.3	-	-	-	-	-	-	-	-	-	-	-	-	3x50.8	16.0	3x(3x63)	-	-	-
	EL 90	90	3x22.5	-	-	-	-	-	-	-	-	-	-	-	-	3x56.5	25.0	3x(3x80)	-	-	-
	EL 105	105	3x26.3	-	-	-	-	-	-	-	-	-	-	-	-	-	-	-	3x37.9	16.0	3x(3x63)
	EL 120	120	3x30.0	-	-	-	-	-	-	-	-	-	-	-	-	-	-	-	3x43.3	16.0	3x(3x63)
	EL 135	135	3x33.8	-	-	-	-	-	-	-	-	-	-	-	-	-	-	-	3x48.7	16.0	3x(3x63)
4xM	EL 105	105	4x20.3	-	-	-	-	-	-	-	-	-	-	-	-	4x50.8	16.0	4x(3x63)	-	-	-
	EL 120	120	4x22.5	-	-	-	-	-	-	-	-	-	-	-	-	4x56.5	25.0	4x(3x80)	-	-	-
	EL 152	152	4x28.5	-	-	-	-	-	-	-	-	-	-	-	-	-	-	-	4x41.1	16.0	4x(3x63)
	EL 160	160	4x30.0	-	-	-	-	-	-	-	-	-	-	-	-	-	-	-	4x43.3	16.0	4x(3x63)
	EL 180	180	4x33.8	-	-	-	-	-	-	-	-	-	-	-	-	-	-	-	4x48.7	16.0	4x(3x63)

				415V/3~/50...60 Hz			440V/3~/50...60 Hz			460V/3~/50...60 Hz			480V/3~/50...60 Hz			500V/3~/50...60 Hz			600V/3~/50...60 Hz			
		Max. steam capacity in kg/h	Nominal power max. in kW	Nominal current max. in A	Cable cross section A _L min. in mm ²	Heating voltage fuse "F5" in A	Nominal current max. in A	Cable cross section A _L min. in mm ²	Heating voltage fuse "F5" in A	Nominal current max. in A	Cable cross section A _L min. in mm ²	Heating voltage fuse "F5" in A	Nominal current max. in A	Cable cross section A _L min. in mm ²	Heating voltage fuse "F5" in A	Nominal current max. in A	Cable cross section A _L min. in mm ²	Heating voltage fuse "F5" in A	Nominal current max. in A	Cable cross section A _L min. in mm ²	Heating voltage fuse "F5" in A	
S	EL 5	5	3.8	5.2	1.0	3x10	4.9	1.0	3x6	4.7	1.0	3x6	4.5	1.0	3x6	4.3	1.0	3x6	3.6	1.0	3x6	
	EL 8	8	6.0	8.3	1.5	3x10	7.9	1.5	3x10	7.5	1.5	3x10	7.2	1.5	3x10	6.9	1.5	3x10	5.8	1.5	3x10	
	EL 10	10	7.5	10.4	1.5	3x16	9.8	1.5	3x16	9.4	1.5	3x16	9.0	1.5	3x16	8.7	1.5	3x10	7.2	1.5	3x10	
	EL 15	15	11.3	15.7	2.5	3x20	14.8	2.5	3x20	14.1	2.5	3 x 20	13.5	1.5	3x16	13.0	1.5	3x16	10.8	1.5	3x16	
M	EL 20	20	15.0	20.9	4.0	3x25	19.7	4.0	3x25	18.8	4.0	3x25	18.0	4.0	3x25	17.3	2.5	3x20	14.4	2.5	3x20	
	EL 24	24	18.0	25.0	6.0	3x32	23.6	6.0	3x32	22.6	6.0	3x32	21.7	4.0	3x25	20.8	4.0	3x25	17.3	2.5	3x20	
	EL 30	30	22.5	31.3	10.0	3x40	29.5	10.0	3x40	28.2	10.0	3x40	27.1	6.0	3x32	26.0	6.0	3x32	21.7	4.0	3x25	
	EL 35	35	26.3	36.5	16.0	3x63	34.4	10.0	3x40	32.9	10.0	3x40	31.6	10.0	3x40	30.3	7.0	3x35	25.3	6.0	3x32	
	EL 40	40	30.0	41.7	16.0	3x63	39.4	16.0	3x63	37.7	16.0	3x63	36.1	16.0	3x63	34.6	10.0	3x40	28.9	10.0	3x40	
	EL 45	45	33.8	47.0	16.0	3x63	44.3	16.0	3x63	42.4	16.0	3x63	40.6	16.0	3x63	39.0	16.0	3x63	32.5	10.0	3x40	
	EL 45	45	2x17.3	-	-	-	-	-	-	-	-	-	-	-	-	-	-	-	-	-	-	-
2xM	EL 50	50	2x18.8	2x26.1	6.0	2x(3x32)	2x24.6	6.0	2x(3x32)	2x23.5	6.0	2x(3x32)	2x22.6	6.0	2x(3x32)	2x21.7	4.0	2x(3x25)	2x18.0	4.0	2x(3x25)	
	EL 60	60	2x22.5	2x31.3	10.0	2x(3x40)	2x29.5	10.0	2x(3x40)	2x28.2	10.0	2x(3x40)	2x27.1	6.0	2x(3x32)	2x26.0	6.0	2x(3x32)	2x21.7	4.0	2x(3x25)	
	EL 70	70	2x26.3	2x36.5	16.0	2x(3x63)	2x34.4	10.0	2x(3x40)	2x32.9	10.0	2x(3x40)	2x31.6	10.0	2x(3x40)	2x30.3	10.0	2x(3x40)	2x25.3	6.0	2x(3x32)	
	EL 80	80	2x30.0	2x41.7	16.0	2x(3x63)	2x39.4	16.0	2x(3x63)	2x37.7	16.0	2x(3x63)	2x36.1	16.0	2x(3x63)	2x34.6	10.0	2x(3x40)	2x28.9	10.0	2x(3x40)	
	EL 90	90	2x33.8	2x47.0	16.0	2x(3x63)	2x44.3	16.0	2x(3x63)	2x42.4	16.0	2x(3x63)	2x40.6	16.0	2x(3x63)	2x39.0	16.0	3x(3x63)	2x32.5	10.0	2x(3x40)	
	EL 50	50	37.5	52.1	16.0	3x63	-	-	-	-	-	-	-	-	-	-	-	-	-	-	-	-
	EL 60	60	45.0	62.6	25.0	3x80	-	-	-	-	-	-	-	-	-	-	-	-	-	-	-	-
L	EL 70	70	52.5	73.0	35.0	3x100	-	-	-	-	-	-	-	-	-	-	-	-	-	-	-	
	EL 80	80	60.0	83.5	35.0	3x100	-	-	-	-	-	-	-	-	-	-	-	-	-	-	-	
	EL 90	90	67.5	93.9	50.0	3x125	-	-	-	-	-	-	-	-	-	-	-	-	-	-	-	
	EL 70	70	3x18.0	-	-	-	-	-	-	-	-	-	-	-	-	-	-	-	-	-	-	
	EL 80	80	3x20.3	-	-	-	-	-	-	-	-	-	-	-	-	-	-	-	-	-	-	
3xM	EL 90	90	3x22.5	-	-	-	-	-	-	-	-	-	-	-	-	-	-	-	-	-	-	
	EL 105	105	3x26.3	3x36.5	16.0	3x(3x63)	-	-	-	-	-	-	-	-	-	-	-	-	-	-	-	
	EL 120	120	3x30.0	3x41.7	16.0	3x(3x63)	-	-	-	-	-	-	-	-	-	-	-	-	-	-	-	
	EL 135	135	3x33.8	3x47.0	16.0	3x(3x63)	-	-	-	-	-	-	-	-	-	-	-	-	-	-	-	
	EL 105	105	4x20.3	-	-	-	-	-	-	-	-	-	-	-	-	-	-	-	-	-	-	
4xM	EL 120	120	4x22.5	-	-	-	-	-	-	-	-	-	-	-	-	-	-	-	-	-	-	
	EL 152	152	4x28.5	4x39.6	16.0	4x(3x63)	-	-	-	-	-	-	-	-	-	-	-	-	-	-	-	
	EL 160	160	4x30.0	4x41.7	16.0	4x(3x63)	-	-	-	-	-	-	-	-	-	-	-	-	-	-	-	
	EL 180	180	4x33.8	4x47.0	16.0	4x(3x63)	-	-	-	-	-	-	-	-	-	-	-	-	-	-	-	

9.2 Operating data

Control steam output	
– active	0...5 VDC, 1...5 VDC, 0...10 VDC, 2...10 VDC, 0...20 VDC, 0...16 VDC, 3.2...16 VDC, 0...20 mADC, 4...20 mADC
– passive	all potentiometric humidity sensors from 140 Ω...10 kΩ
– On/Off control	<2.5 VDC --> Off; ≥2.5 VDC...20 VDC --> On
Duct air pressure	-1.0 kPa to 1.5 kPa; upto 10.0 kPa with optional overpressure kit
Admissible ambient temperature	1...40 °C
Admissible ambient humidity	1...75 %rh (non-condensing)
Water supply	
– Admissible water supply pressure	1...10 bar (with optional drain water cooling 2...10 bar)
– Admissible Feed temperature	1...40 °C (with optional drain water cooling 1...25 °C)
– Water quality	Untreated drinking water with a conductivity of 125 to 1250 μS/cm)
Water drain	
– Drain water temperature	80...90 °C (with optional drain water cooling <60 °C)
Protection class	IP21

9.3 Connections/Dimensions/Weights

Water supply connector	G 3/4»
Water drain connector	ø30 mm
Steam connector	ø45.0 mm
Housing dimensions	
– Small unit (S) - H x W x D	670 mm x 420 mm x 370 mm
– Medium unit (M) - H x W x D	780 mm x 530 mm x 406 mm
– Large unit (L) - H x W x D	780 mm x 1000 mm x 406 mm
Unit weights	
– Small unit (S) - Net weight/operating weight	24.1 kg / 34.1 kg
– Medium unit (M) - Net weight/operating weight	35.5 kg / 58.6 kg
– Large unit (L) - Net weight/operating weight	57.3 kg / 105.0 kg

9.4 Certificates

Certificates	CE, VDE
--------------	---------

CONSULTING, SALES AND SERVICE:



CH94/0002.00

